

VU155 Series Ice and Beverage Dispensers

Order parts online
www.follettice.com

Installation, Operation and Service Manual

Service numbers above B50000

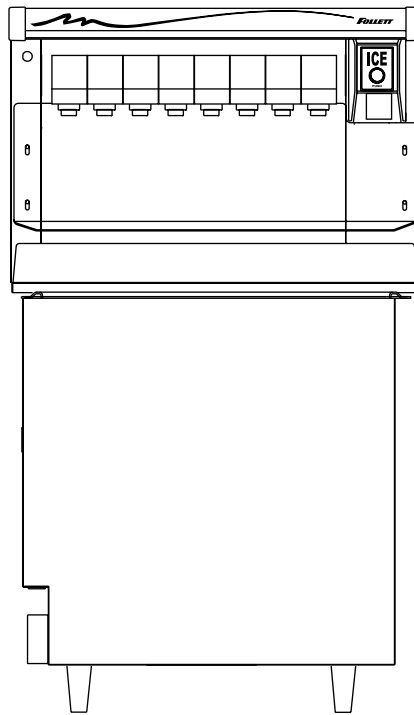

**Following installation, please forward this manual
to the appropriate operations person.**

Table of contents

Welcome to Follett Corporation	3
Important cautions	3
Specifications	4
Installation	6
Installing dispenser in counter	6
Field wiring diagrams	7
Installing optional ice machine	7
Connecting beverage lines	8
Operation	8
How the dispenser works	8
Cleaning	9
Service	11
Dispense chute cover removal	11
Auger motor assembly removal	11
Gate assembly removal	11
Auger and auger tube removal	11
Dispenser wheel removal	11
Wiring diagrams	12
Troubleshooting	13
Replacement parts	15

Welcome to Follett

Follett equipment enjoys a well-deserved reputation for excellent performance, long-term reliability and outstanding after-the-sale support. To ensure that this dispenser delivers that same degree of service, we ask that you take a moment to review this manual before beginning the installation of the dispenser. Should you have any questions or require technical help at any point, please call our technical service group at (877) 612-5806 or +1 (610) 252-7301.

Before you begin

After uncrating and removing all packing material, inspect the equipment for concealed shipping damage. If damage is found, notify the shipper immediately and contact Follett Corporation so that we can help in the filing of a claim, if necessary.

Check your paperwork to determine which model you have. Follett model numbers are designed to provide information about the type and capacity of Follett ice dispensing equipment. Following is an explanation of the different model numbers in the VU155 series.

VU155B8LP

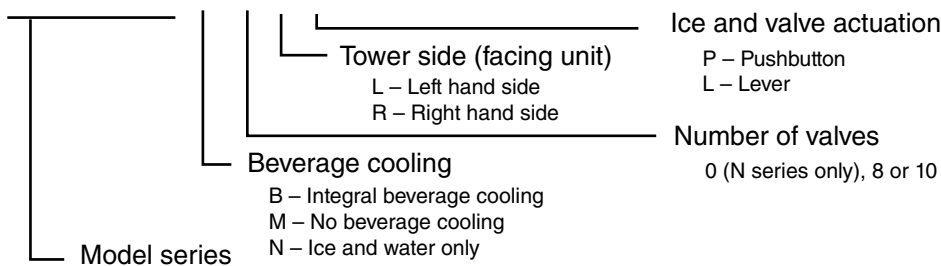

Warranty Registration and Equipment Evaluation

Thank you for purchasing Follett® equipment. Our goal is to deliver high value products and services that earn your complete satisfaction by delivering high-value products and services backed by outstanding customer and technical support. Please review the installation instructions thoroughly. It is important that the installation be performed to factory specifications so your equipment operates at its maximum efficiency.

Follett LLC will not be liable for any consequential damages, expenses, connecting or disconnecting charges, or any losses resulting from a defect of the machine. For full warranty details, visit our website www.follettice.com/productwarranties. Registering your equipments helps Follett track your equipment's service history should you need to contact us for technical support, and your feedback helps us improve our products and services. Please visit www.follettice.com/support to complete the Warranty Registration form.

Should you have any questions, please contact Follett's technical support group at (877) 612-5086 or (610) 252-7301 and we will be happy to assist you.



Important cautions

For indoor use only.

Storage area of dispenser contains mechanical, moving parts. Keep hands and arms clear of this area at all times. If access to this area is required, power to unit must be disconnected first.

Ice is slippery. Maintain counters and floors around dispenser in a clean and ice-free condition.

Ice is food. Follow recommended cleaning instructions to maintain cleanliness of delivered ice.

Always disconnect power before cleaning or servicing the dispenser.

Failure to remove all sanitizer may result in health hazard.

Follett manual load dispensers can accommodate most cube/cubelet ices up to 1" square, or Follett compressed nugget ice. Crushed, flake, bagged, nugget or congealed ice cannot be used. Use of these ices can jam dispenser and void warranty. Separate any "waffle-like" sections of cubes before adding to dispenser. For ice compatibility questions, please call Follett customer service at (877) 612-5806 or +1 (610) 252-7301.

Specifications

Electrical

Each ice machine and dispenser require a separate circuit with electrical disconnect within 10 ft (6 m). Equipment ground required. Standard electrical – 115V, 60Hz, 1 phase. Maximum dispenser fuse – 15 amps. For ice machine circuit requirements, refer to the ice machine specification sheet.

Model number	Dispenser amperage
VU155M series (no integral beverage cooling)	2.4 amps
VU155B series (integral beverage cooling)	4.4 amps

Plumbing

Dispenser 3/4" PVC pipe nipple for bin drain
 3/4" PVC pipe nipple for drain pan drain
 1" ID hose for beverage bath drain

Beverage connections

1/4" ID syrup beverage hose
3/8" ID carbonated water beverage hose
3/8" ID plain water beverage hose

Note: Drains should be hard piped and insulated. Maintain at least 1/4" per foot (6 mm per 304 mm run) slope on drain line run.

Water disconnect within 10 feet (3 m) of dispenser is suggested for automatic load units.

Follett recommends use of a Follett water filter system (part# 00130229) on ice machines connected to automatic fill dispensers.

Ice machine Refer to detailed specifications in ice machine installation manual packed with ice machine

Dimensions and clearances

Required clearances

- 51" (1295 mm) minimum above counter for installation if dispenser will be dropped into counter
- 36" (915 mm) minimum above counter for all units after installation for auger cleaning and servicing
- 12" (305 mm) minimum on side opposite ice chute for service
- 12" (305 mm) minimum on ice chute side if ice transport tube enters this side
- 12" (305 mm) minimum between dispenser side(s) and optional ice machine(s)

Front View

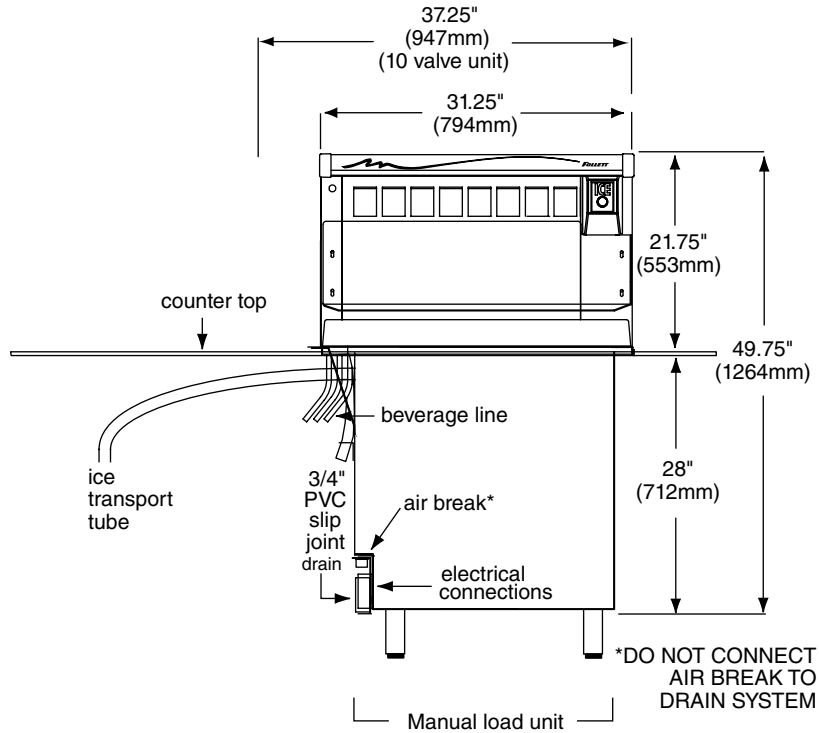

Side View

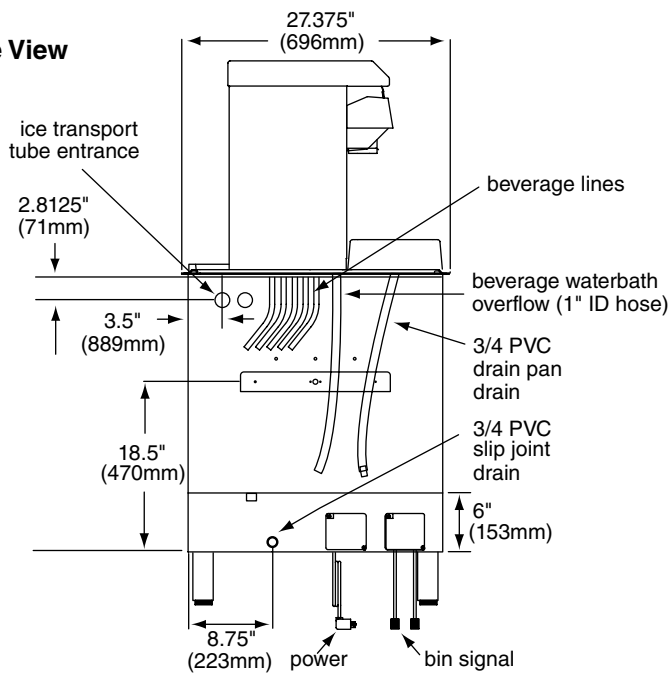

Installation

Installing dispenser in counter

Note: All dispensers must be supported from below with supplied 6" – 9" (153 – 229 mm) adjustable leg accessory, or equivalent. Do not hang dispenser on flange.

All dispensers must be installed level in both directions to ensure proper operation.

1. Check that dispenser location meets all requirements in this manual and cut counter as shown.

Plan View
units with up to 8 valves counter cut-out

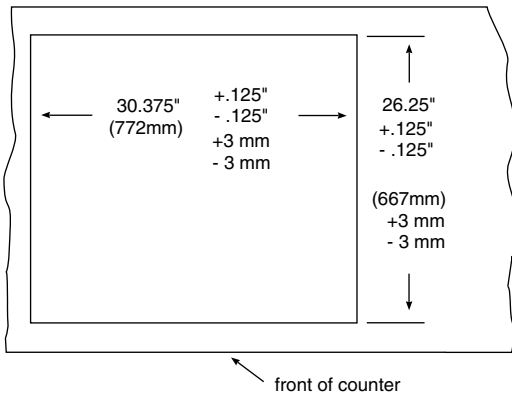

Plan View
units with 10 valves counter cut-out

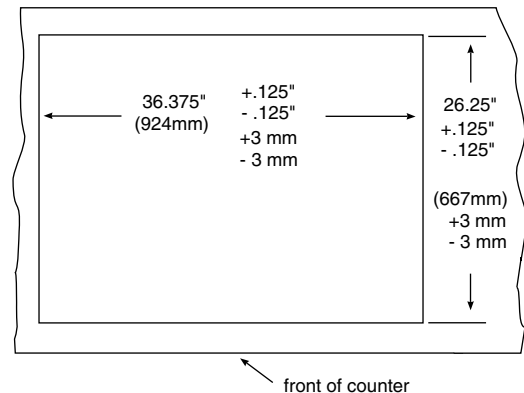

2. Place support blocks in cabinet to raise dispenser to a height of 12" (305 mm).
3. Place dispenser in counter onto support blocks.
4. Attach adjustable legs to dispenser.
5. Remove support blocks and lower dispenser feet to floor.
6. Adjust legs for 1/8" (4 mm) clearance between dispenser lip and countertop to verify there is no load on flange.
7. Apply a bead approximately 1/4" (6 mm) in diameter of NSF-listed silicone sealant (Dow Corning RTV-732 or equivalent) around perimeter of dispenser where it meets counter. Smooth sealant to a 1/8" (4 mm) radius.
8. Install a PVC drain line with at least a 1/4" per foot (20 mm per 1 m) slope. Insulate drain line to prevent condensation.

Note: Do not apply excessive heat if any sweating of fittings is necessary. Heat conduction through metal may melt threads in plastic drain.

Do not reduce drain line size or tie drains together.

9. Make electrical connections in accordance with applicable wiring diagrams provided. Provide disconnects within 10 ft (3 m) of dispenser and ice machine for servicing.

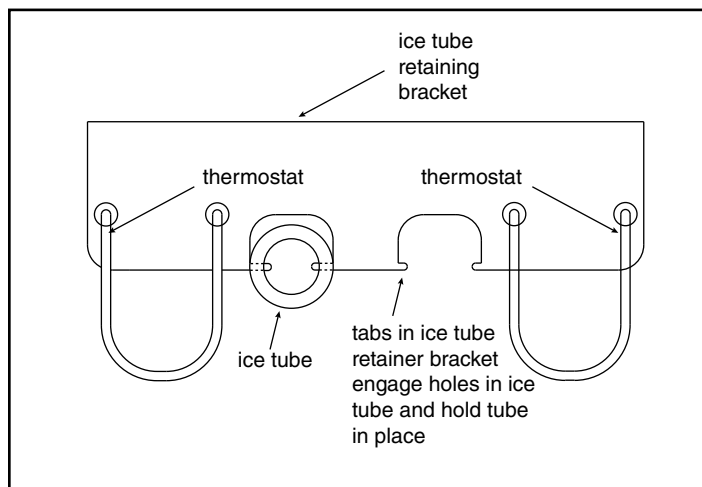

Field wiring diagrams

Note: Field wiring diagrams are intended to aid electricians or technicians in understanding how equipment works. All field wiring must be installed in accordance with all local and NEC codes.

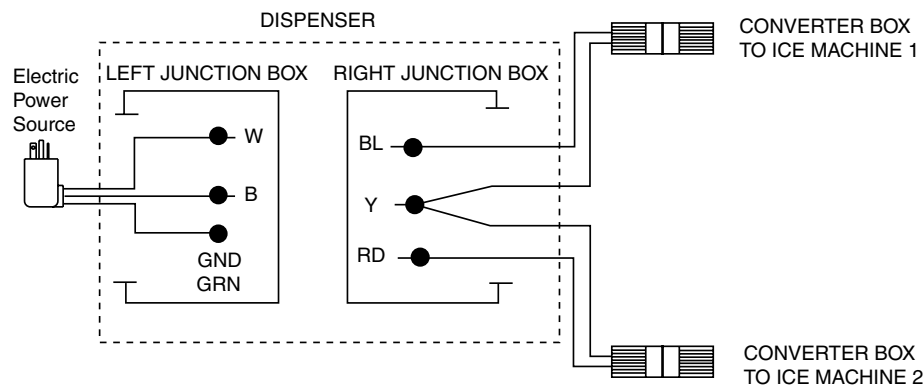

Installing optional auto-fill ice machine kit(s)

Correct installation of RIDE™ model ice machines is critical to proper performance of ice machine. Refer to installation manual packed with ice machine for important details on ice transport tube run, ventilation requirements and other installation requirements. Failure to comply with instructions may void warranty.

To start and operate dispenser

1. Follow detailed cleaning instructions in service manual before operating dispenser.
2. On units with Follett integral ice water bath beverage cooling (“B” models) only, slowly pour water into ice water bath area to fill empty bath and submerge coils. Coils are submerged when water starts to flow out overflow drain. **DO NOT SPLASH WATER ON ELECTRICAL BOX.** Once filled with water, add ice to bath until ice covers top of water bath.
3. For manual load units, remove front drain pan or rear lid and fill storage area with approved ice.

Note: Follett manual load dispensers can accommodate most cube/cubelet ices up to 1" square, or Follett compressed nugget ice. Crushed, flake, bagged, nugget or congealed ice cannot be used. Use of these ices can jam dispenser and void warranty. Separate any “waffle-like” sections of cubes before adding to dispenser. For ice compatibility questions, please call Follett customer service at (877) 612-5806 or +1 (610) 252-7301.

4. Turn power switch located on dispenser control box to ON position.
5. For automatic fill units, follow detailed instructions in ice machine installation section of installation manual, then turn ice machine (bin signal) switch(es) located on dispenser control box to ON position and begin to make ice.
6. When dispenser has at least 6" (153 mm) of ice in storage area, test operation.

Connecting beverage lines

1. Connect syrup and water lines. Non-carbonated water line will be labeled “water.” Syrup lines are numbered and correspond to the valves as shown in drawing(s) below. Valve one is always next to ice tower.
2. The center 4 valves are pre-plumbed to both carbonated and non-carbonated water lines with the QuickCARB™ beverage manifold. Valves can be individually changed from a carbonated to a non-carbonated flavor with the flip of a lever (see below).
3. Clean and sanitize beverage lines according to cleaning instructions.

Valve position #1 is always next to ice tower. Right-hand unit shown.

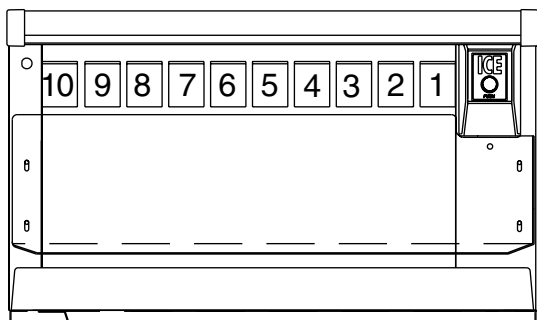

VU155B QuickCARB manifold
(see dispenser for model specific QuickCARB configuration)

Rear View

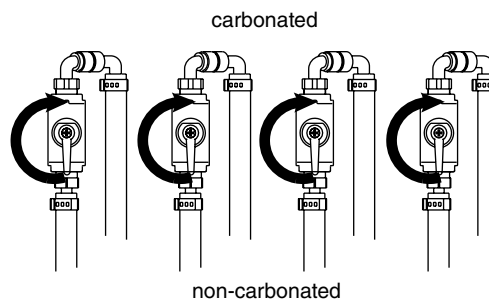

Operation

How the dispenser works

Follett's dispensers are available in automatic load configurations, fed from one or two Follett RIDE model ice machines or manual load configurations (using ice from another source).

In all models, ice is stored below the counter in the dispenser storage area. When the dispense lever or button is pushed, the dispense motors are activated. This causes the wheel assembly in the storage area to turn, moving ice to the vertical auger assembly, which carries ice up to the dispense chute where it drops by gravity into the container.

In automatic load units, ice is manufactured in either one or two Follett RIDE model ice machines. These ice machines may be located up to 20 ft (6 m) away from the dispenser. Extruded ice is transported through a tube and pushed to the storage compartment of the dispenser. When the bin is filled, a bin thermostat shuts the ice machine off to avoid overfilling of the bin. The ice machine will restart after 20 minutes if the bin is calling for ice.

Units with integral ice water bath beverage cooling are equipped with a water bath timer circuit that activates the water bath pump for 35 minutes when ice lever or button is activated, or when the ice water bath warms up and calls for more ice.

Ice movement

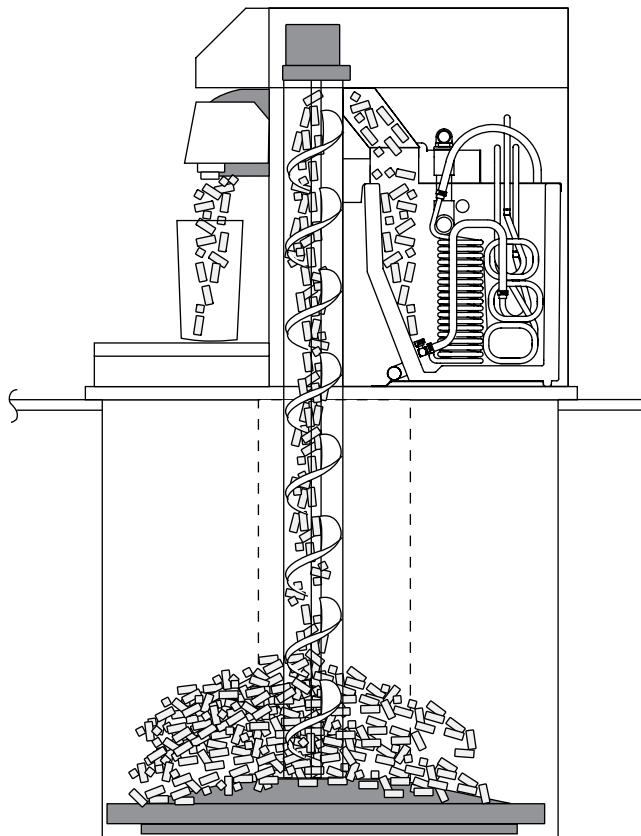

Cleaning

Using solutions below, clean and sanitize storage area and beverage lines before starting unit and on a routine basis as noted below.

Note: Always disconnect power before cleaning dispenser.

Do not run plastic parts through a dishwasher.

Solution A: Combine 1 oz (30 ml) bleach with 2 gal (8 L) hot water.

Solution B: Combine 1/4 oz (7 ml) bleach with 2 gal (8 L) hot water.

Note: Cleaning solutions temperature must be at 75 F – 125 F (24 C to 52 C)

Recommended cleaning prior to start up

Cleaning ice storage area before use

1. Refer to disassembly instructions (see Service section) and remove dispense wheel from ice storage area.
2. Remove auger, auger tube and dispense mechanism.
3. Wipe all components and ice storage area with cleaning Solution A.
4. Rinse all components and ice storage area thoroughly with clear, potable water.
5. Wipe all components and ice storage area with sanitizing Solution B.

Cleaning beverage lines

Prepare 6 gallons (23 L) of cleaning Solution A. Fill a clean product tank with cleaning solution. Fill a second clean product tank with potable rinse water.

1. Disconnect all syrup lines from product containers.
2. Connect syrup line #1 to cleaning solution tank, pressurize tank to 20-50 psi, and dispense 1/2 gallon (2 L) of solution into a suitable container from valve #1.
3. Connect syrup line #1 to rinse tank, pressurize tank to 20-50 psi, and dispense 3 gallons (11 L) into a suitable container from valve #1.
4. Repeat this cleaning and rinsing for all syrup lines.
5. Remove diffusers and nozzles from valves, soak in cleaning solution, rinse well and reinstall.

Sanitizing beverage lines

Prepare 6 gallons (23 L) of sanitizing Solution B. Fill a clean product tank with this solution.

1. Connect one tank to syrup line #1. Dispense 1/2 gallon (2 L) from valve #1.
2. Repeat for all remaining syrup lines, allowing sanitizing solution to remain in all circuit lines for 15 minutes.
3. Connect a clean, empty tank (pressurized to 50 psi) to each syrup line and blow out sanitizer by operating each valve.
4. Remove diffusers and nozzles from valves, soak in sanitizing solution for 15 minutes, rinse well and reinstall.
5. Reconnect all lines and dispense product through valves to purge any remaining sanitizer.

Recommended daily dispenser cleaning

1. Remove all debris from drain pan.
2. Pour 1 gallon (4 L) hot water into drain pan to keep drain lines clear.

Recommended weekly dispenser cleaning

1. Remove drain pan and grille and wash with Solution A. Rinse thoroughly.
2. Remove nozzles and diffusers from valves, soak for at least 10 minutes in cleaning Solution A, rinse, sanitize with Solution B and reinstall.
3. Pour a solution of one cup (8 oz/237 ml) household bleach mixed with one gallon (3.8 L) hot water into drain pan to help prevent algae growth in drain lines.

Recommended quarterly dispenser cleaning

1. Remove top from dispenser and turn power switch to OFF position.
2. Remove ice from storage area.
3. Remove dispense chute cover, chute, auger motor assembly, auger and auger tube (see Service section).
4. Remove drain pan, grille and dispense wheel (see Service section).
5. Clean all components and bin storage area with Solution A, rinse thoroughly with clear water and sanitize with Solution B.
6. Remove nozzles and diffusers from valves, soak for at least 10 minutes in cleaning Solution A, rinse, sanitize with Solution B and reinstall.

For units with integral ice-water bath beverage cooling only:

1. Remove dispenser lid and counter access panel opposite ice tower side.
2. Disengage service drain tube (on utility connection side of dispenser) from mounting bracket.
3. Pull bath service drain tube down through beverage line opening in counter and drain water bath into a bucket.
4. Use a bottle brush to clean coils with Solution A, rinse and sanitize with Solution B.
5. Reposition ice water bath drain tube in up position so water does not drain out.
6. Pour Solution A into ice water bath until it flows out of bath overflow drain.
7. Turn power ON to unit and dispense a small cup of ice to activate pump.
8. Allow pump to run for two minutes to clean pump and pump lines.
9. Turn power OFF.
10. Drain bath and replace drain tube in mounting bracket in up position to avoid siphoning water bath water.

Putting unit back in service after quarterly cleaning

1. On units with integral beverage cooling, fill ice water bath with water until water spills out of bath overflow drain.
2. Reassemble components.
3. For manual load units, fill unit with an approved ice (see important cautions on page 4).
4. For automatic load units with 400A/W (R404A refrigerant) ice machines, turn bin signal switch(es) and dispenser power switch to ON position and allow storage area to fill.
5. Dispense and discard all ice, verifying dispenser is functioning properly.

Recommended quarterly cleaning of optional ice machine.

Units equipped with optional ice machines require cleaning of ice machine system at least every six months, and more often if local water conditions dictate. Failure to clean ice machine system will result in decreased performance and potential damage to ice machine. Refer to Ice machine Installation, Operation and Service Manual.

Service

Dispense chute cover removal

1. Remove top cover.
2. Push chute cover up vertically to slip off holding tab.
3. After clearing tab, pull chute cover forward to remove.

Auger motor assembly removal

1. Remove top cover.
2. Remove one thumbnut on rear of motor bracket.
3. Lift motor bracket and motor up, unplug electric quick disconnects and remove.

Dispense mechanism assembly removal (Fig. 2)

1. Remove top cover.
2. Remove chute cover (see above).
3. Remove auger motor assembly (see above).
4. Remove quick release pins from the ice chutes and gates, then unplug wires from solenoids.
5. Lift dispense mechanism up and off auger tube.

Auger and auger tube removal (Fig. 3)

1. Remove auger motor and dispense mechanism assembly (see above).
2. Pull auger upward to clear auger tube.
3. Lift auger tube upward to clear dispenser top.
4. Slide tube and bearing plate through auger tube gasket.

Dispense wheel removal

1. Remove drain pan assembly and bin access cover.
2. Remove center thumbnut and threaded rod on dispense wheel assembly and lift wheel out front access opening.

Fig. 1 Front View
right hand (RH), 8-valve unit

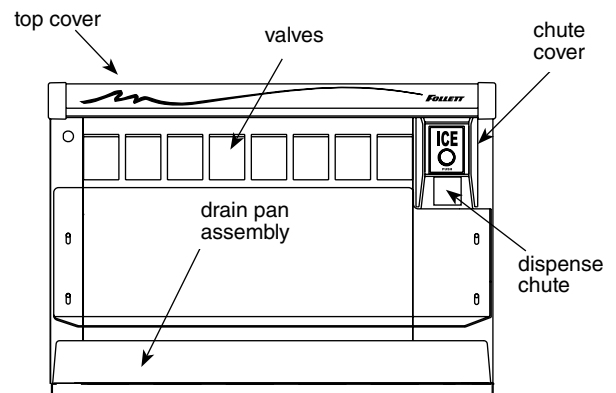

Fig. 2 Top View – Dispense Assembly
(right hand (RH) unit with bath shown)

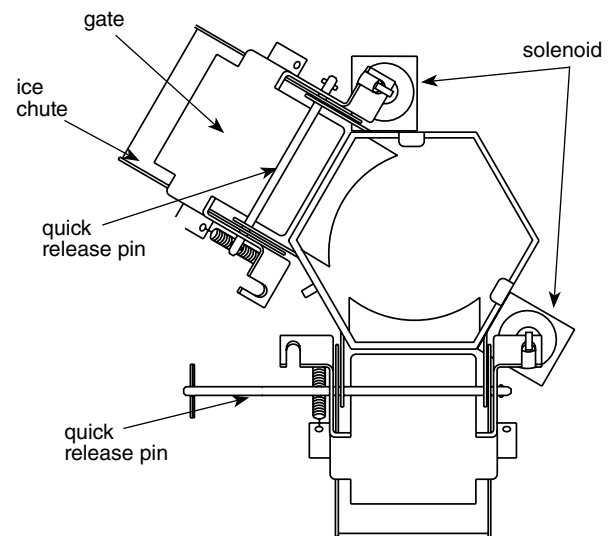
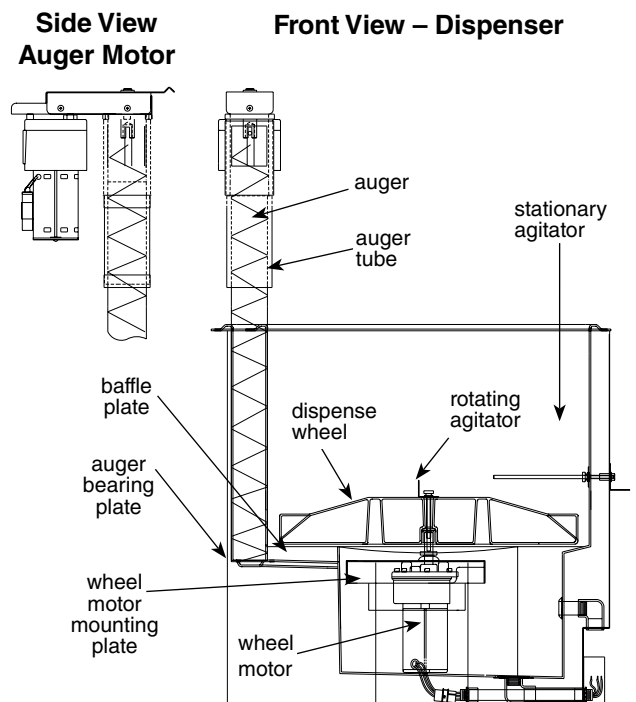
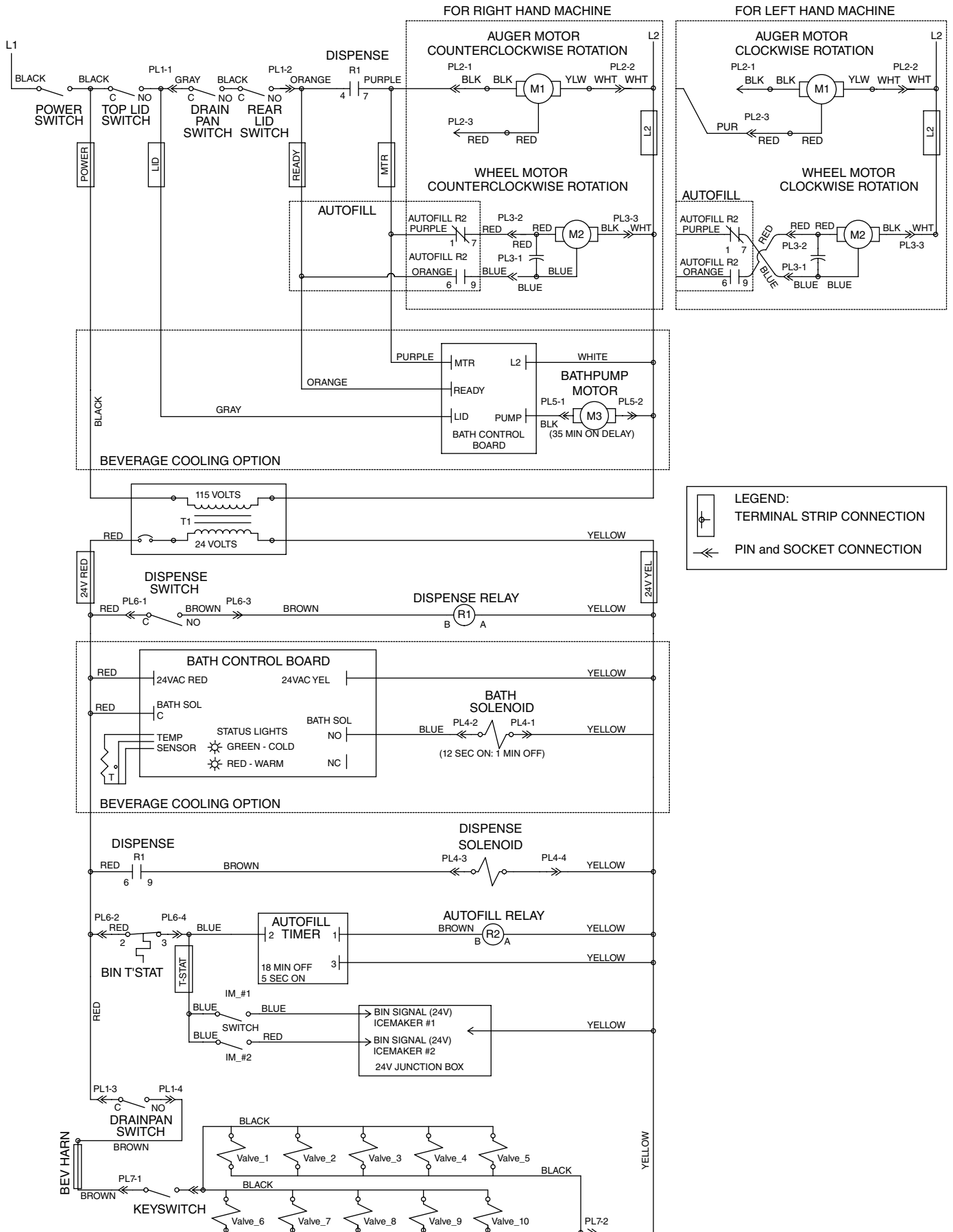

Fig. 3



Wiring diagram



Dispenser troubleshooting guide

Before calling for service

1. Check that ice is in the dispenser and that congealed cubes are not causing a jam.
2. Check that circuit breaker and switches are in ON position.
3. Check that drain pan, rear lid and top are on securely. If ajar, dispenser will not operate. When the top is off, auger does not operate, even though the solenoids do (page 14).
4. Check that all drains are clear.

Note: For units equipped with Follett compressed nugget ice machine, see Ice machine Operation and Service Manual for service and troubleshooting information.

Symptom	Possible cause	Solution
Ice does not dispense. <ul style="list-style-type: none"> • Auger motor does not run • Wheel motor does not run 	<ol style="list-style-type: none"> 1. Power switch faulty or in OFF position; loose connection. 2. Faulty dispense switch. 3. Faulty transformer. 4. Drain pan ajar. 5. Faulty drain pan safety switch. 	<ol style="list-style-type: none"> 1. Turn power switch to ON position; check connections. 2. Replace switch. 3. Replace transformer. 4. Check pan and reset. 5. Replace switch.
Ice does not dispense. <ul style="list-style-type: none"> • Auger motor runs • Wheel motor runs • Gate does not open 	<ol style="list-style-type: none"> 1. Loose electrical connection. 2. Linkage problem between solenoid and gate. 3. Faulty solenoid. 	<ol style="list-style-type: none"> 1. Check connections. 2. Check linkage. 3. Replace solenoid.
Ice does not dispense. <ul style="list-style-type: none"> • Auger motor does not run • Wheel motor runs 	<ol style="list-style-type: none"> 1. Loose electrical connection. 2. Faulty auger motor. 3. Faulty run capacitor. 	<ol style="list-style-type: none"> 1. Check connections. 2. Check auger motor. 3. Check run capacitor.
Ice does not dispense. <ul style="list-style-type: none"> • Auger motor runs • Wheel motor does not run 	<ol style="list-style-type: none"> 1. Loose electrical connection. 2. Faulty wheel motor. 3. Faulty run capacitor. 	<ol style="list-style-type: none"> 1. Check connections. 2. Check wheel motor. 3. Check capacitor.
Warm drinks or soda foaming.	<ol style="list-style-type: none"> 1. No ice in storage bin. 2. Water drained out of ice water bath. 3. Circulating pump not running. 	<ol style="list-style-type: none"> 1. Fill storage area with ice or check ice machine operation. 2. Check that ice water bath drain tube is in fixed upright position. 3. Check pump and PC board for output.
No ice in dispenser.	<ol style="list-style-type: none"> 1. Power switch in OFF position or faulty. 2. Bin signal switches in OFF position or faulty. 3. Faulty bin thermostat. 4. Faulty transformer. 5. Ice machine related problem. 6. Faulty or disconnected wiring. 	<ol style="list-style-type: none"> 1. Check switch and replace if necessary. 2. Check switch and replace if necessary. 3. Replace bin thermostat. 4. Replace transformer. 5. Refer to ice machine Operation and Service Manual for diagnosing. 6. Check for power and bin signal on ice machine PC board.

If problems persist after following this basic troubleshooting guide, call Follett's technical service department at (877) 612-5806 or +1 (610) 252-7301.

Operational Status

The chart below shows the operational status of various parts when certain switches are turned off or accessories are removed.

Condition	Pump	Solenoids	Auger	Wheel	Beverage valves
Top lid off	OFF	ON	OFF	OFF	ON
Rear lid off	ON	ON	OFF	OFF	ON
Drain pan off	ON	ON	OFF	OFF	OFF
On/off switch in off position	OFF	OFF	OFF	OFF	OFF
Beverage switch in OFF position	ON	ON	ON	ON	OFF

Water bath circuit board operation

The temperature sensor is hard wired directly to the circuit board. The water bath circuit board operates on 24 volts AC. The bath pump will run for 35 minutes whenever ice is dispensed or the bath calls for ice.

Optimal beverage temperature is controlled by the circuit board located in the electrical box. The board monitors the water bath temperature and holds it to a factory setting. When the Red LED is ON, the bath solenoid, auger motor, wheel motor and bath pump are energized. Ice will be dispensed into the water bath for 12 seconds, then stop for 60 seconds. The pump will stay energized, and the circuit board will then monitor the water temperature. If it is below the set point, the Green LED will come on, the Red LED light will go off, and ice will not dispense into the water bath. If the temperature of the bath is determined to be above the set point, the Red LED will remain on. The circuit board has a delay of 60 seconds before more ice is dispensed into the water bath.

LED indicators:

Green – the water bath is at the set temperature.

Red – the bath temperature is above the set temperature and the bath is calling for ice.

Flashing LED indicators:

Flashing Red and Green – the circuit board has gone into an **error mode**:

Alternate flashing – circuit board has power and is waiting for hopper cover and dispenser top to be replaced.

Simultaneous flashing – the water bath did not reach set temperature in 40 minutes. Reset this error mode by turning power off, removing top lid, drain pan or rear lid.

Electrical box Front View

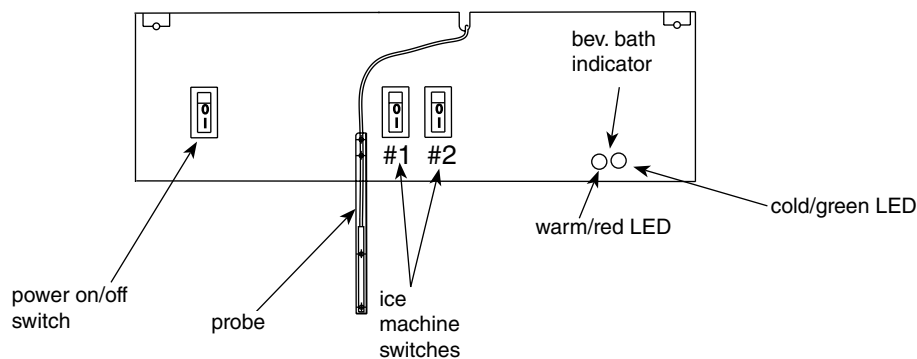

Replacement parts

Order parts online
www.follettice.com

Dispenser exterior

Top – 8 Valve Unit with Right Hand (RH) Tower

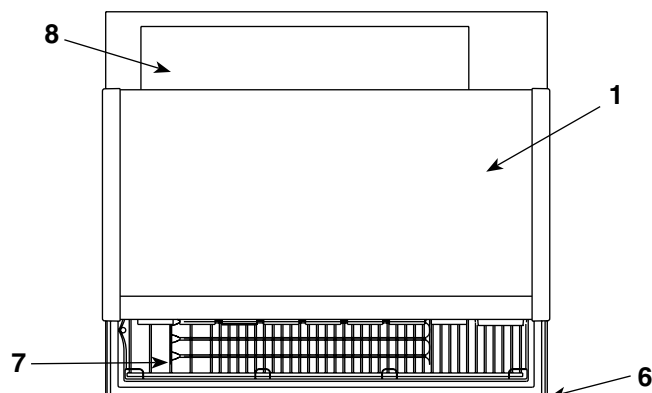

Front – 8 Valve Unit with Right Hand (RH) Tower
(push-button dispensing)

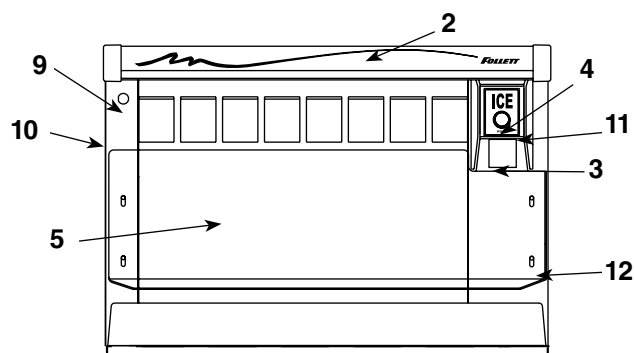

Reference #	Description	Part #
1	Lid, 8 valve unit (includes "Follett" label)	502436
1	Lid, 10 valve unit (includes "Follett" label)	502437
2	Label, "Follett"	502438
3	Cover, dispense chute, lever operation	502439
3	Cover, dispense chute, black push-button (includes button)	502620
3	Chute cover, dispense, push-button, ice (includes stainless steel switch and label)	01156470
4	Switch, black push-button	502441
4	Switch, push-button, stainless steel, ice (includes label)	01145507
5	Backsplash, RH unit, 8 valves	502445
Not shown	Backsplash, LH unit, 8 valves	502444
Not shown	Backsplash, RH unit, 10 valves	502443
Not shown	Backsplash, LH unit, 10 valves	502442
6	Drain pan, 8 valve unit	502446
Not shown	Drain pan, 10 valve unit	502447
7	Grille, drain pan, 8 valve unit	502450
Not shown	Grille, drain pan, 10 valve unit	502451
8	Cover, ice storage bin, rear — all U155 units (except N units)	502452
Not shown	Cover, ice storage (under drain pan) — all U155 units	502453
9	Switch, key lock for valves	501409
Not shown	Key, beverage lock switch	501286
10	Panel, end, beverage, RH unit	502584
Not shown	Panel, end, beverage, LH unit	502583
Not shown	Panel, access, RH and LH units	502585
Not shown	Panel, rear, motor support, RH unit	502586
Not shown	Panel, rear, motor support, LH unit	502587
Not shown	Panel, front, dispense mechanism, RH unit	502588
Not shown	Panel, front, dispense mechanism, LH unit	502589
Not shown	Panel, rear, 8 valve	502590
Not shown	Panel, rear, 10 valve	502591
11	Label, ice, dispense cover, push-button	502623
Not shown	Label, ice, dispense cover, lever	502622
Not shown	Clip, Tinnerman, 10-32	502621
12	Thumbscrew, backsplash, 10-32 x 1/2	501100
Not shown	Legs, 6" (153 mm) adjustable to 9" (229 mm) — set of 4	502454
Not shown	Screw, 10-32 x 1/2	502287
Not shown	Plug 2 lead, male	502333
Not shown	Plug 2 lead, female	502334
Not shown	Push pin, clear chute	502618

Dispense assembly

Order parts online
www.follettice.com

Side View (RH unit with bath shown)

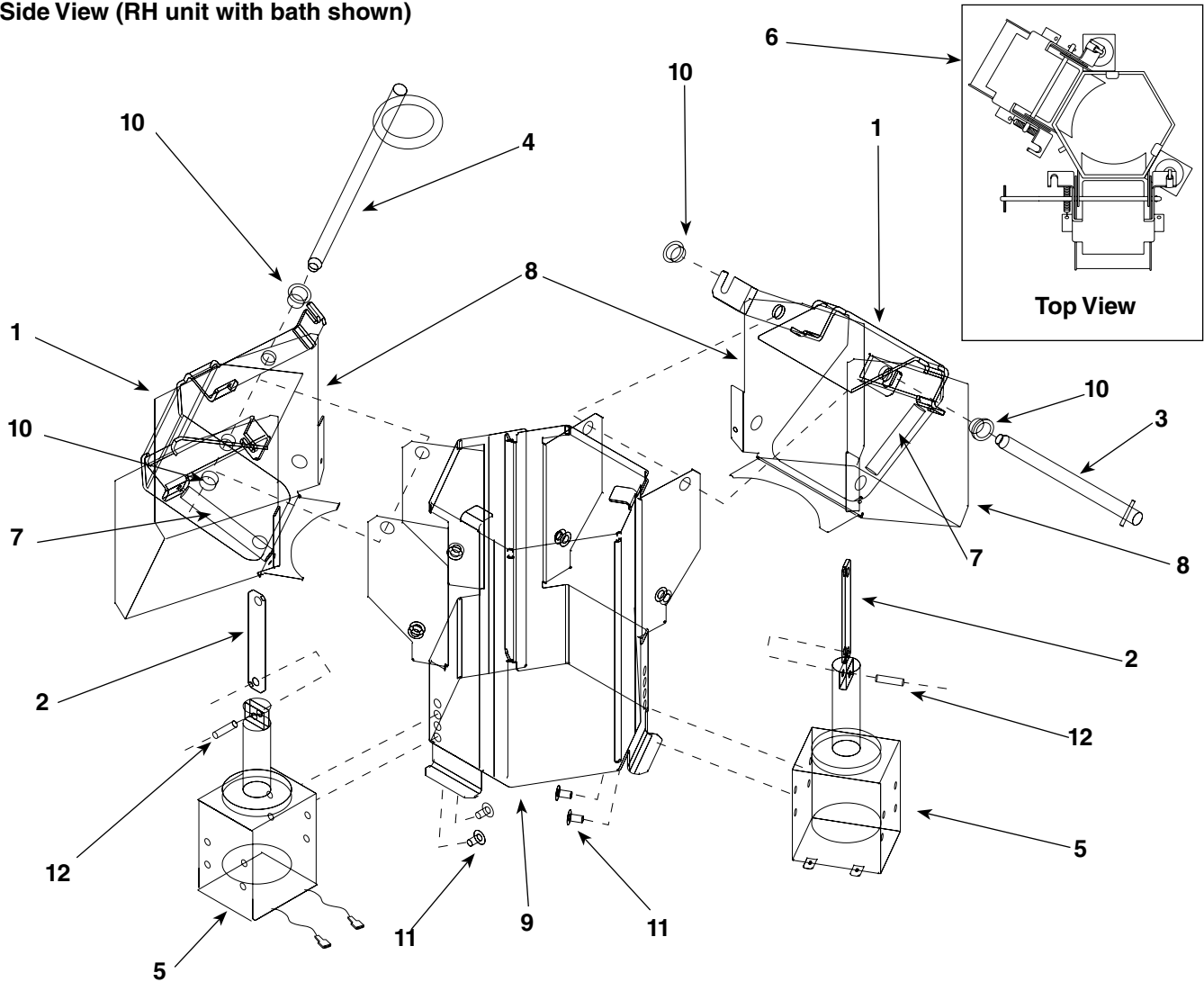

Reference #	Description	Part
1	Gate, dispense	502455
2	Linkage pin, gate/solenoid	502456
3	Pin, quick release, 3" (77 mm), bath gate and lever	501949
4	Pin, quick release, 5.53" (141 mm), dispense gate	502102
5	Solenoid (includes linkage pin)	00126607
6	Dispense mechanism assembly, bath, RH unit	502448
Not shown	Dispense mechanism assembly, bath, LH unit	502449
Not shown	Dispense mechanism assembly, non-bath RH unit	502458
Not shown	Dispense mechanism assembly, non-bath, LH unit	502496
7	Spring, dispense mechanism (1 per side)	501950
8	Chute, ice	502457
9	Wrap, dispense mechanism	502607
10	Bushing, Ni liners	501249
11	Screw, 8-32 x 5/16	502625
12	Pin, spring	502624
Not shown	Push pins, clear chute	502618
Not shown	Chute, focus – clear plastic	502459
Not shown	Lever, dispense	501953

Side View

Top View

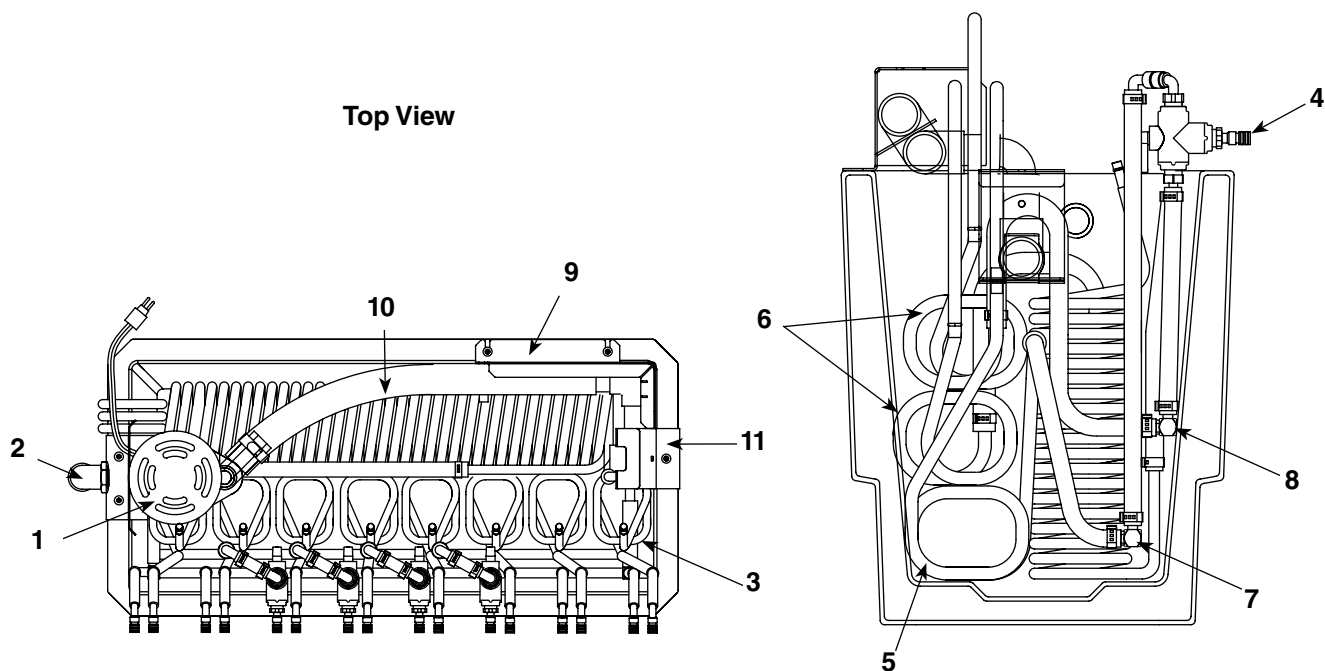

Reference #	Description	Part #
1	Pump, water bath (includes mounting plate and elbow)	00111476
2	Elbow, overflow drain, 1" (26 mm) x 3/4 MPT	502465
Not shown	Elbow, clean-out drain, 3/8" (10 mm) x 3/8 MPT	502466
3	Coil, syrup	00125864
4	Valve, QuickCARB assembly	00126979
5	Coil, carbonated water, 8 valve	00119792
Not shown	Coil, carbonated water, 10 valve	00119560
6	Coil, water/carb, 8 valve	00124628
Not shown	Coil, water/carb, 10 valve	00124701
7	Manifold, carbonated water, 8 valve	207539
Not shown	Manifold, carbonated water, 10 valve	207540
8	Manifold, water, 8 valve	00123331
Not shown	Manifold, water, 10 valve	00123141
9	Shield, splash, RH	00125435
Not shown	Shield, splash, LH	00125393
10	Pump, discharge assembly, RH, 8 valve	00127001
Not shown	Pump, discharge assembly, LH, 8 valve	00127019
Not shown	Pump, discharge assembly, RH, 10 valve	00127027
Not shown	Pump, discharge assembly, LH, 10 valve	00127035
11	Bracket, mounting, outlet	00111633

Hopper

Order parts online
www.follettice.com

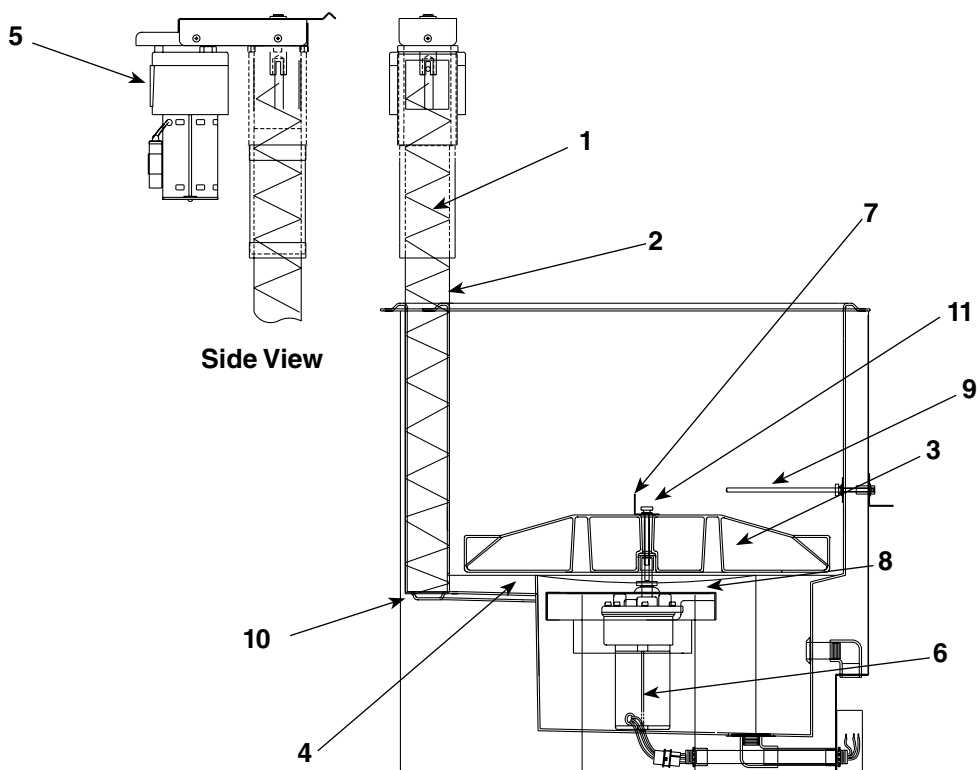

Reference #	Description	Part #
1	Auger, LH unit (black, stamped with "1")	502491
Not shown	Auger, RH unit (gray, stamped with "2")	502492
2	Tube, auger, LH unit with beverage bath	502486
Not shown	Tube, auger, RH unit with beverage bath	502485
Not shown	Tube, auger, RH unit without beverage bath	502487
Not shown	Tube, auger, LH unit without beverage bath	502488
3	Wheel, dispense (includes stud and rotating agitator)	501681
4	Baffle (under dispense wheel)	501684
Not shown	Drive bar (under dispense wheel)	501682
5	Motor, vertical auger	502476
6	Motor, wheel	502560
Not shown	Seal, wheel motor	501333
Not shown	Spacer, wheel motor	501768
Not shown	Capacitor, wheel motor	501782
7	Agitator, rotating, 21" (534 mm) long	502484
8	Plate, wheel motor mounting	502615
9	Agitator, stationary	502490
10	Plate, auger bearing	501696
Not shown	Bracket, ice tube, double tube	502497
Not shown	Ice transport tube (sold by the foot)	500366
Not shown	Ice transport tube, 10 ft	502522
Not shown	Ice transport tube, 20 ft	502523
Not shown	Insulation, transport tube (sold by the foot)	501176
Not shown	Cover, blank ice entry	502674
Not shown	Thermostat	501432
Not shown	Gasket, ice entry	502673
Not shown	Plate, ice entry, 2 holes	502674
11	Stud, wheel mount	00913400

Auger motor

Order parts online
www.follettice.com

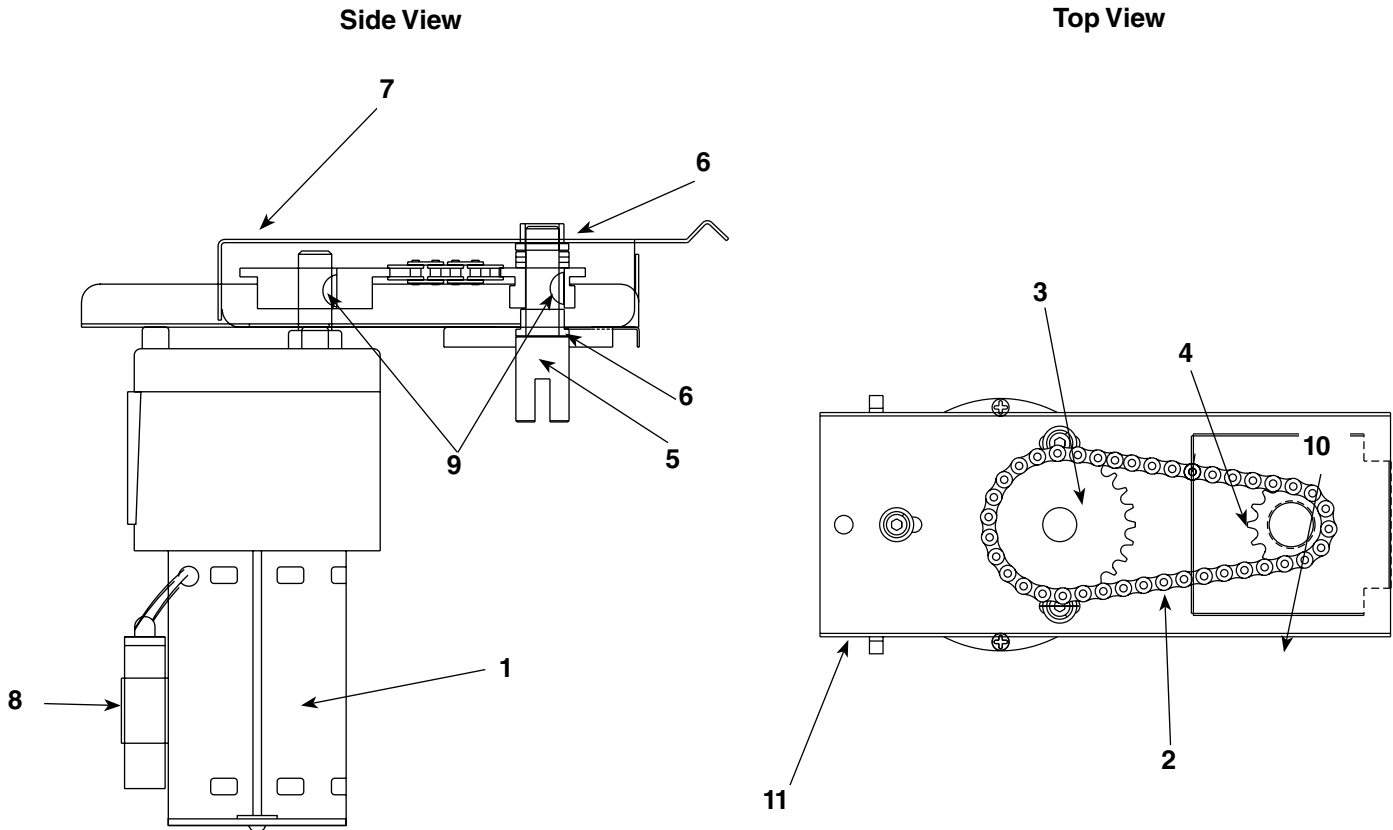

Reference #	Description	Part #
Auger motor/drive assembly, vertical (includes all items below)		502493
1	Motor, vertical auger (includes gearbox and capacitor)	502476
2	Chain, auger drive #35, 42 link	00931790
3	Sprocket #35, 22T 5/8 bore	502478
4	Sprocket #35, 12T 5/8 bore	502479
5	Drive shaft	502480
6	Bearing, auger, upper and lower	501314
7	Cover and bearing, chain drive (includes 501314)	502481
8	Capacitor, 25mf, 270V	501550
9	Key, Woodruff	502482
10	Washers, thrust, (4)	501765
11	Mounting plate, auger motor (includes 501314)	502483

For dispensers with serial number C74152 and above only:

1 Motor, vertical auger (includes capacitor) 00907170

For dispensers with serial number below C74152 only:

2 Chain, auger drive #35, 40 link 502477

Electrical components

Order parts online
www.follettice.com

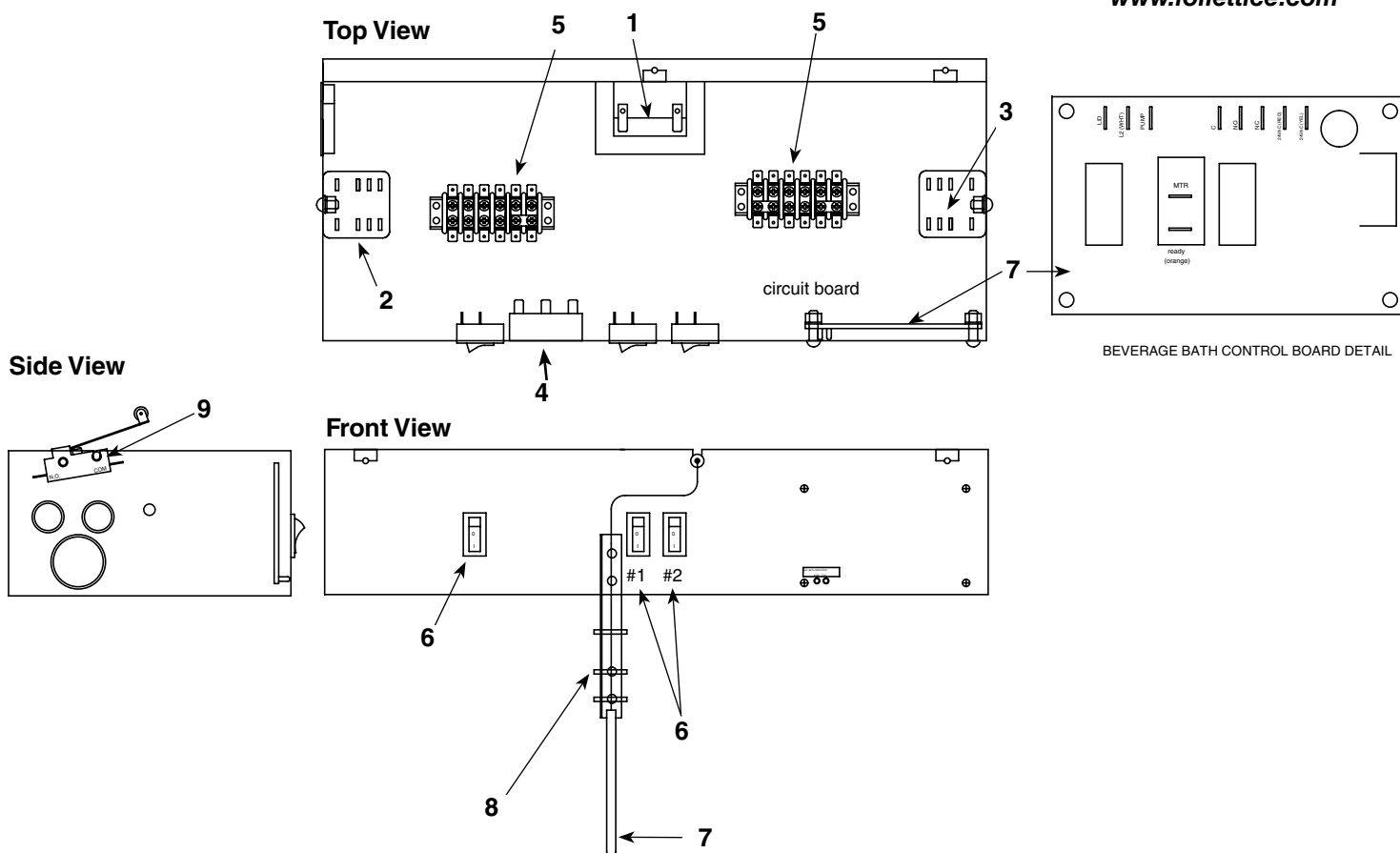

Reference #	Description	Part #
1	Transformer, 24V	502058
2	Relay, auto fill	501826
3	Relay, dispense	501826
4	Timer, auto fill (automatic fill units)	502471
5	Strips, terminal	502472
6	Switches (power and ice machine)	502209
7	Board, circuit and probe (one unit)	502473
8	Bracket, probe	502474
9	Switch, safety	502511
Not shown	Switch, safety, rear cover assembly, LH unit	502498
Not shown	Switch, safety, rear cover assembly, RH unit	502499
Not shown	Switch, safety, drain pan assembly, LH unit	502500
Not shown	Switch, safety, drain pan assembly, RH unit	502501
Not shown	Switch, dispense, lever	502505
Not shown	Bracket, safety switch, rear	502608
Not shown	Bracket, safety switch, drain pan, RH	502609
Not shown	Bracket, safety switch, drain pan, LH	502610
Not shown	Thermostat, bin level	500514
Not shown	Converter box, bin signal	01067156
Not shown	Relay	01020734

RIDE and QuickCARB are trademarks of Follett LLC.
Chewblet is a registered trademark of Follett LLC, registered in the US.