

Installation, Operation and Service Manual

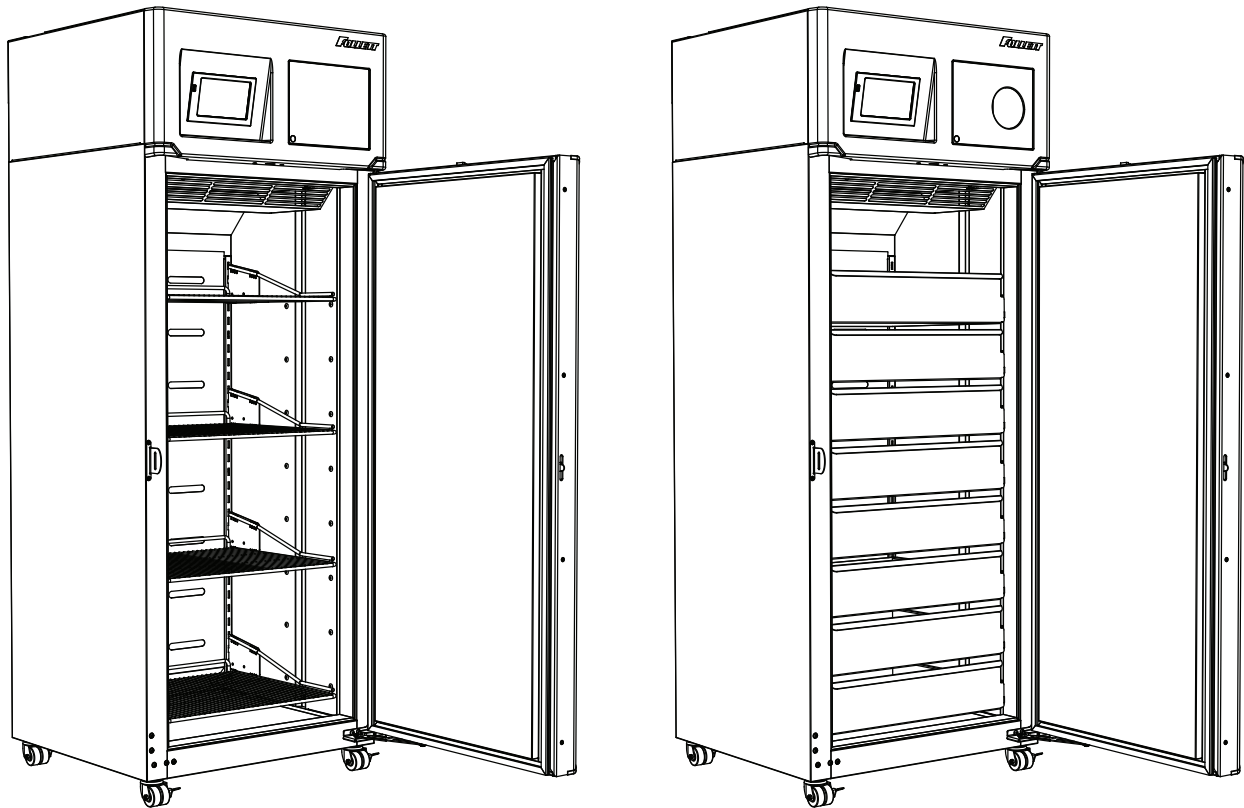

Welcome to Follett Products LLC

Follett Products equipment enjoys a well-deserved reputation for excellent performance, long-term reliability and outstanding after-the-sale support. To ensure that this equipment delivers that same degree of service, review this guide carefully before you begin your installation.

Should you need technical help, please call our Technical Service group at (877) 612-5086 or (610) 252-7301.

Please have your model number, serial number and complete and detailed explanation of the problem when contacting Technical Service.

Getting Started

After uncrating and removing all packing material, inspect the equipment for concealed shipping damage. All freight is to be inspected upon delivery. If visible signs of damage exist, please refuse delivery or sign your delivery receipt “damaged.” Follett Customer Service must be notified within 48 hours. Wherever possible, please include detailed photos of the damage with the original packaging so that we may start the freight claim process.

Preliminary Information

Caution Symbols



Warning: Flammable Refrigerant



Caution: Risk of danger to operator or harm to equipment. Refer to manual.

DANGER

- Risk of fire or explosion. Flammable refrigerant used.

Before attempting to install or service this product, all safety precautions must be followed.

CAUTION! – Risk of fire or explosion. Dispose of properly in accordance with federal or local regulations. Flammable refrigerant used.

CAUTION! – Risk of fire or explosion due to puncture of refrigerant tubing; follow handling instructions carefully. Flammable refrigerant used.

CAUTION! – Handling, moving, and operating the refrigerator to avoid either damaging the refrigerant tubing or increasing the risk of a leak.

CAUTION!

- If the equipment is not transported vertically, a period of at least 24 hours must be allowed before starting.

The equipment must be transported and handled exclusively in upright position. This is required to avoid contamination of the refrigerant with compressor oil. Contamination could result in valve and heat exchanger coil failure, problems starting the electric motor, or the risk of gas leak. The manufacturer is not responsible for any problems due to transport executed in conditions other than those specified.

The equipment must be handled using a fork lift truck or a pallet truck with suitable forks (fork length at least equal to 2/3 length of unit).

WARNING!

- Read this manual thoroughly before operating, installing or performing maintenance on the equipment. Failure to follow instructions in this manual can cause property damage, injury or death.
- The machine contains R600a refrigerant. R600a (isobutane) is flammable.
- When servicing the equipment, be sure to lock the circuit breaker, and display an in-service notice.
- This equipment contains high-voltage electricity and refrigerant charge. Installation and repairs are to be performed by properly trained technicians aware of the dangers of dealing with high voltage electricity and refrigerant under pressure. The technician must also be certified in proper refrigerant handling and servicing procedures. All lockout and tag out procedures must be followed when working on this equipment.
- Repair on R600a systems must always be done in a well-ventilated area.
- Because R600a is highly flammable, a combustible gas leak detector is required when servicing R600a systems.
- Keep ventilation openings, in the appliance enclosure or in the built-in structure, clear of obstruction.
- Do not use mechanical devices or other means to accelerate the defrosting process, other than those recommended by the manufacturer.
- Do not damage the refrigerant circuit.
- Do not store explosive substances such as aerosol cans with a flammable propellant in this appliance.
- Do not use electrical appliances inside the food storage compartments of the appliance, unless they are of the type recommended by the manufacturer.
- Only use parts recommended or provided by the manufacturer.
- Do not tilt unit further than 30° off vertical during uncrating or installation.
- If the supply cord is damaged, it must be replaced by the manufacturer, its service agent or similarly qualified persons in order to avoid a hazard.
- This appliance is designed for commercial use.
- To reduce risk of shock, disconnect power before servicing.

General Information

- To avoid a rise in temperature in the cabinet and/or contents, only open the door for brief periods of time.
- In the refrigerator compartment, put stored items on the shelves and do not let them contact the wall.

Check your paperwork to determine which configuration you have. Follett configuration numbers are designed to provide information about the type of refrigerator you are receiving.

| Specifications | | | | |
|---|---|---|---|---|
| | FZR20i-4S | FZR25i-4S | FZR20i-PL | FZR25i-PL |
| Capacity | 19.7 ft ³ (558 L) | 24.6 ft ³ (697 L) | 19.7 ft ³ (558 L) | 24.6 ft ³ (697 L) |
| Usable Space | 12.7 ft ³ (0.36 m ³) | 16.8 ft ³ (0.48 m ³) | 13.8 ft ³ (0.39 m ³) | 18.2 ft ³ (0.52 m ³) |
| Storage system | (4) epoxy-coated shelves | (4) epoxy-coated shelves | (8) stainless drawers | (8) stainless drawers |
| Exterior width | 29.75" (76 cm) | 29.75" (76 cm) | 29.75" (76 cm) | 29.75" (76 cm) |
| Exterior depth | 29" (74 cm) | 35" (89 cm) | 29" (74 cm) | 35" (89 cm) |
| Exterior depth with handles | 30.5" (78 cm) | 36.5" (93 cm) | 30.5" (78 cm) | 36.5" (93 cm) |
| Exterior height with casters | 79.5" (202 cm) | 79.5" (202 cm) | 79.5" (202 cm) | 79.5" (202 cm) |
| Interior dimensions (w x d x h) | 24" x 22.5" x 56" (61 cm x 58 cm x 143 cm) | 24" x 28.5" x 56" (61 cm x 73 cm x 143 cm) | 24" x 22.5" x 56" (61 cm x 58 cm x 143 cm) | 24" x 28.5" x 56" (61 cm x 73 cm x 143 cm) |
| Approx. ship weight | 449 lb (203 kg) | 485 lb (220 kg) | 539 lb (244 kg) | 598 lb (271 kg) |
| Net weight | 379 lb (172 kg) | 414 lb (188 kg) | 469 lb (213 kg) | 527 lb (239 kg) |
| BTU/hr normal heat rejection (75 F ambient) | 1090 BTU/hr (320 Watts) | 1090 BTU/hr (320 Watts) | 1090 BTU/hr (320 Watts) | 1090 BTU/hr (320 Watts) |
| BTU/hr maximum (total) heat rejection, at maximum compressor speed (75 F ambient) | 2630 BTU/hr (770 Watts) | 2660 BTU/hr (780 Watts) | 2630 BTU/hr (770 Watts) | 2660 BTU/hr (780 Watts) |

| Standard features – all models | |
|--------------------------------|--|
| Door | Solid, insulated, stainless steel |
| Door handle | ADA-compliant, full length handle with integral lock |
| Interior/exterior material | Heavy-duty, corrosion resistant stainless steel |
| Casters | (4) dual-wheel swiveling casters with toe locks |
| Insulation | 2.75" (7 cm) thick, CFC-free foam insulation throughout |
| Air circulation system | Ducted air through 16 back plenum openings with front face return |
| Temperature probe | Stainless steel RTD (resistance temperature detector). Immersible with panel quick-disconnect. One at top on all models. One at bottom on PL models. |

Refrigeration System

The FZR20i/25i series refrigeration system is designed to give many years of trouble-free service. Except for routine cleaning of the air-cooled condenser and related parts, the refrigeration system requires no service or maintenance. The system uses a thermostatic expansion valve (TXV) metering device and is critically charged. Access fittings are not provided. Temporary piercing valves are required to work on the refrigeration system. Follett recommends that if hoses are ever connected to the refrigeration system for service, the refrigerant should be recovered, permanent access valves should be installed and the system evacuated, and recharged by weighing in the correct refrigerant charge (refrigerant R290, 2.8 oz (80g)).

Note: Do not charge the system by pressures.

Ambients

Intended for indoor use where:

- Ambient temperature (measured at the condenser inlet) does not exceed 86 F (30 C)
- Ambient relative humidity does not exceed 60% RH
- Altitude is below 2000 m
- Environment is classified as Pollution Degree 2

Clearances

The top of the freezer must have 16 inches (41 cm) of clear space above the freezer to ensure proper ventilation of the refrigeration system.

The back of the freezer should have 2 inches (5 cm) of clearance behind the freezer.

Ensure placement of freezer does not prevent access to main power cord plug for disconnection.

Electrical specifications

- 115 V \pm 10%, 60 Hz, 1 phase
- Running load amps: 2.6A with fascia heater energized
- Full load amps (90% maximum continuous current per UL/CSA/IEC 61010-1 at 40 C): 7.5A
- Minimum circuit ampacity: 15A dedicated circuit
- **Maximum size of branch circuit overcurrent device: 15A dedicated circuit**
- Follett recommends circuit be protected by GFCI breaker
- Product main power cord must be plugged into an outlet that is properly connected to protective earth ground
- Overvoltage Category II

Refrigeration specifications

- Refrigerant R290, 2.8 oz (80 g)
- Compressor amperage: RLA - 6.15 A, LRA - 6.15 A
- Compressor winding resistances: C-S (4.6 Ω +/- 8%), C-R (4.6 Ω +/- 8%)
- Evaporator fan motor amperage: FLA - 0.2 A
- Condenser fan motor amperage: FLA - 0.4 A
- Condenser inlet air temperature: 75 F (23.9 C)
- Discharge pressure (psi): 244
- Suction pressure (psi): 129

Heater specifications

- Evaporator heater: 400 W, 2.98A–4.0A, 31 Ω –35 Ω
- Drain pan heater: 85 W, 0.63A–0.86A, 148 Ω –163 Ω
- Drain tube heater: 15 W, 0.11A–0.15A, 909 Ω –1005 Ω
- Total in parallel (defrost heaters): 3.88A–5.24A, 25 Ω –28 Ω
- Fascia heater: 70 W, 0.47A–0.65A, 196 Ω –216 Ω

Detail drawing

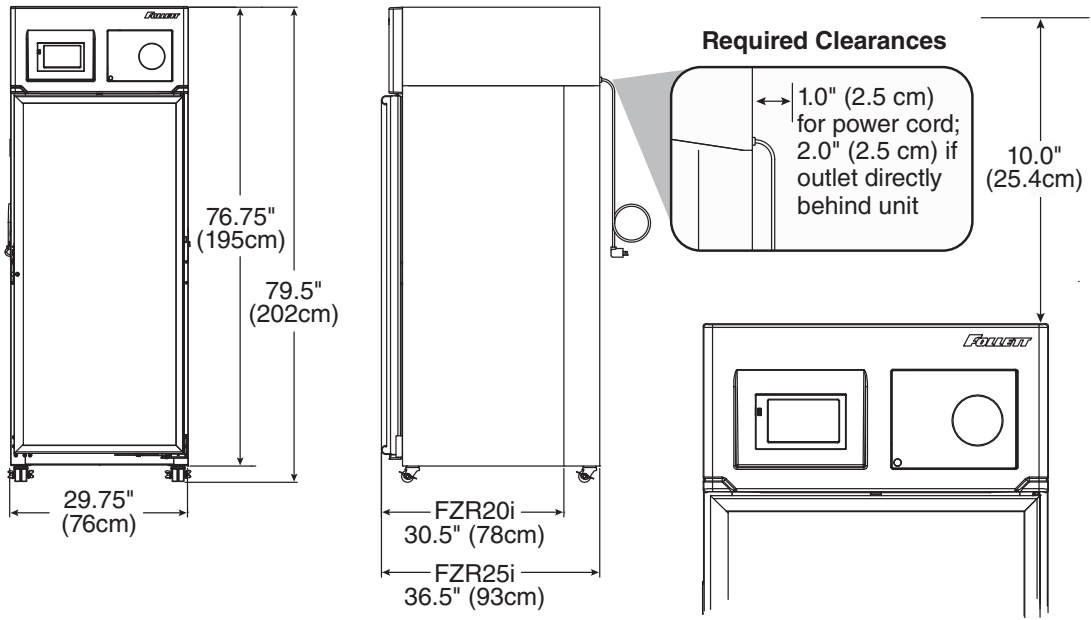

Installation

DANGER



- **Do not tilt any unit further than 30° off vertical during uncrating or installation**
- **Refrigeration module area contains mechanical, moving parts. Keep hands and arms clear of this area at all times. If access to this area is required, power to unit must be disconnected first.**

1. Remove key taped to side of refrigerator cabinet and unlock door.
2. Remove casters from box packed inside refrigerator.
Note: California facilities requiring wall and floor anchors – refer to wall anchor kit instructions (#00938241) packed with seismic kit before proceeding with caster installation.
3. Unbolt refrigerator from pallet.
4. Rotate refrigerator on pallet to install casters (**Fig. 1.1**).
5. Install casters by hand one at a time using channel locks to tighten, until caster meets against the bottom of cabinet (**Fig. 1.2**).
6. Peel protective film from exterior walls of stainless cabinet.

Fig. 1

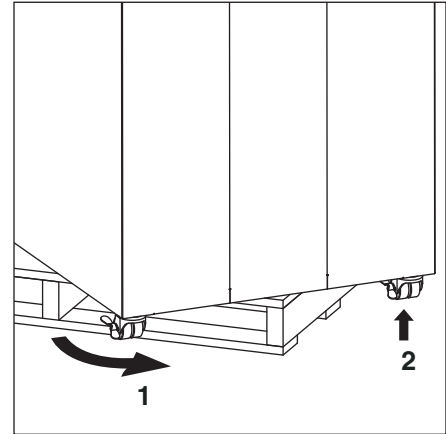

Adjust self-closing door

1. Roll refrigerator to desired location and lock as many casters as possible (**Fig 2.1**).
2. If the door appears to be sagging, remove the philips screw (**Fig. 2.2**) holding the Hold Open Bracket to the Hinge Bracket to gain access to the Sag Adjustment Screw (**Fig. 2.3**). Turn the Sag Adjustment Screw to align the door squarely with the cabinet. When finished, reinstall the Hold Open Bracket.
3. Check door for closing tension and adjust if necessary. To check closing tension, open door 1" and turn screw (**Fig. 2.4**) counterclockwise until you achieve positive close. (Light will go out) Then, turn another half turn counterclockwise.

Fig. 2

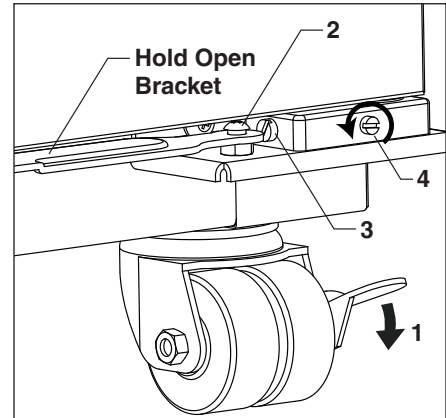

Install shelves (if equipped) and power up

1. If refrigerator is equipped with shelves, remove packaging and then position shelves in desired locations by inserting brackets into pilasters as shown (Fig. 3).
2. Plug refrigerator into a 115 V 60 Hz 15A dedicated outlet.

Attention Installer: In order to maintain compliance to ANSI/NSF 456, do not store product on the bottom floor or against the back or side walls. Product must be stored on a factory supplied shelf, basket or drawer.

Fig. 3

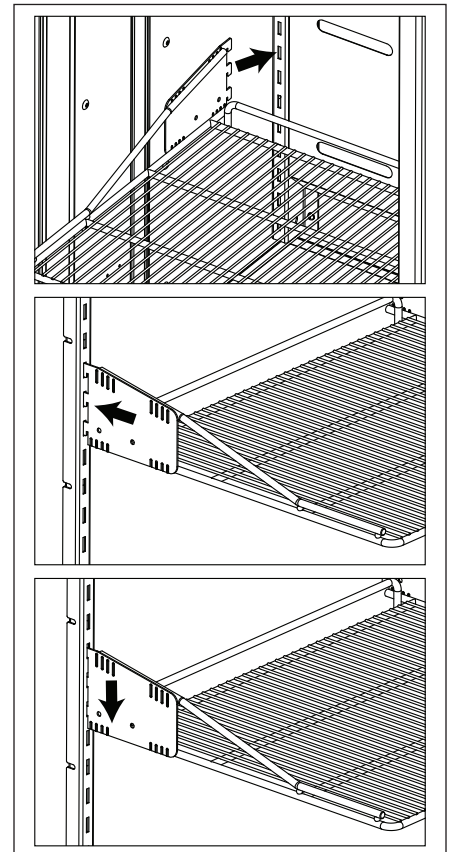

Fill product bottle

ATTENTION INSTALLER

- It is imperative that the top/bottom probe bottle be filled with a solution that your facility uses to ensure proper operation of unit.
- Units are equipped with a third-party monitor installation port. Customers are required to refer to CDC Vaccine and Handling Toolkit (cdc.gov) for proper placement of the probe within the cabinet to ensure proper performance.
- NSF 456 requires the temperature display probe (P4-RTD1 in FZR20i and FZR25i models) to be replaced or recalibrated. Follett recommends replacement/recalibration 12 months from the original date of calibration on the Certificate of Traceability supplied with your equipment at the time of purchase. Recalibration or purchasing a new calibrated probe is not covered by the original equipment warranty. To purchase a new Probe with Certificate of Traceability, please contact our Parts Department @ 1-877-612-5086 or partsales@follettice.com

1. Remove probe and cap from the top bottle and fill with glycerine supplied with unit (e.g., 60% glycerine and 40% water) (Fig. 4). Replace cap and reinsert probe sensor.
2. If equipped with a bottom probe, perform same procedure for bottom bottle.
3. Adhere supplied probe wire clips (x4, packaged with manual) to inside wall leading to the probe bottle.
4. Route probe wire into clips and close the clips.

Fig. 4

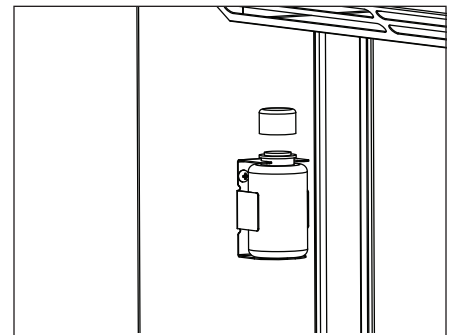

Alarm Output (optional)

The alarm output is a 12 Vdc signal that is turned ON when an alarm is activated. Connection is provided by a 2-circuit JST connector on the back of the control panel labelled **ALARM**.

Two connection options:

- The 12 Vdc signal can input directly into their system if their system is capable of receiving 12 Vdc.
- The output can be utilized to power a 12 Vdc relay (not included) to provide a NO/NC set of contacts.

Power the Unit

1. Press lower left corner of front facade door to access power switch inside (**Fig. 5.1**).

Fig. 5

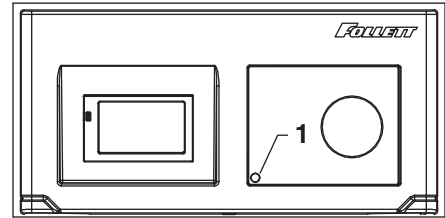

2. Press power switch to turn unit on (**Fig. 6.1**).
3. FZR20i/25i units are equipped with rechargeable batteries. For units equipped with a chart recorder, the 9 V battery back up must be connected at the time of installation.

Fig. 6

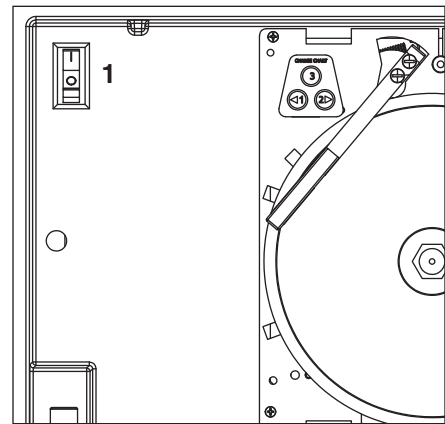

Third-party probe wire routing (if desired)

1. Peel back permagum at the location shown (**Fig. 7**) to expose access port for routing third-party probe into cabinet.
2. Route probe into cabinet through access port and then replace permagum to seal the opening.

Fig. 7 (top view)

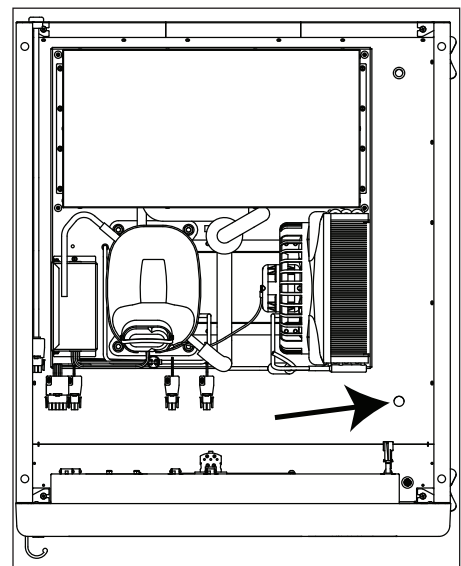

3. Remove front left and right return louver screws to uncover access port (**Fig. 8**).
4. Route probe wire down either side channel in cabinet.
5. If desired, apply extra permagum at interior access port for additional seal.
6. Reinstall louver screws.

Fig. 8

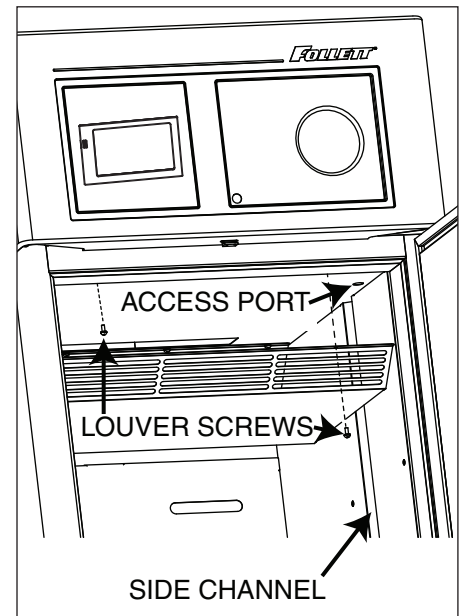

Controller Operation

Use and care of the LCD touchscreen

The LCD touchscreen utilizes capacitive touch technology. This will allow you to engage the functionality by touching the screen with your fingers, even while you are wearing latex or cotton gloves. Functionality will not engage by touching with an inanimate object, such as a pen or stylus.





- To preserve optimal touch sensitivity, keep the screen clean by using a clean, dry cotton cloth.
- Do not expose the screen to liquids or excessive dust, heat or humidity.

Control function icons and navigation buttons engage functionality of the user interface. Status indicators alert the user to a change of status.





Home screen

The Home Screen consists of three primary information areas: the temperature display, control function display zone and system status display.









Control Functions

-  Settings
-  Alarming
-  Light
-  Information log
-  Help

System Status

-  Compressor is running
-  Evaporator fan is running
-  Door is open
-  Defrost cycle is in process

Functions and Settings

-  USB download available (downloading when blinking)
-  Refrigeration set points
-  Sleep functions
-  Centigrade to Fahrenheit
-  Probe set points
-  Alarming functions
-  Alarm mute
-  Reset

- Product temperature is displayed in the upper right corner.
- Current selected display probe above temperature readout.
- Primary control function icons are displayed in the lower left corner.
- System status icons will display in lower right corner to indicate a condition has been activated.



High and low temperature display

From the home screen touch the temperature display in the upper right corner. The high/low temperatures will appear below the temperature display. To the left of the high/low temperature, a time and date stamp will be displayed.

View the bottom probe temperature and min/max temperature log

1. Press the Temperature Display in the upper right hand corner of the display
 - Will initially display MIN/MAX temperature of Top probe.
2. Press a second time to prompt a reset Top probe MIN/MAX.
3. Press a third time to display HIGH/LOW alarm settings.
4. Press a fourth time to display current Bottom probe temperature.
5. Press a fifth time to display Bottom probe MIN/MAX temperature.
6. Press a sixth time for prompt to reset Bottom probe MIN/MAX temperature log..

Reset the high and low temperatures

Touch the temperature display a second time and the reset function  will appear under the high and low temperature. Touch the reset icon and a yellow message box will appear. Press  to confirm reset or  to cancel.

Alarm set point display

From the home screen touch the temperature display three times. The High and Low alarm set point will appear under the temperature. The factory preset alarm values are 2 C (35.6 F) and 8 C (46.4 F).

Fig. 9

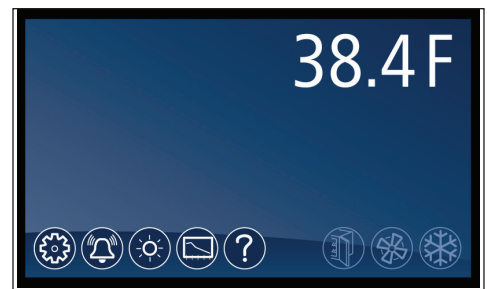

Fig. 10



Fig. 11



Fig. 12



Help



- Help is available at any time by touching the  icon at the bottom of the screen.
- Help is screen-specific; touching the  icon will display an explanation of the functionality and use of the screen you are currently viewing.
- Touch  to exit help screen.

Fig. 13



Settings



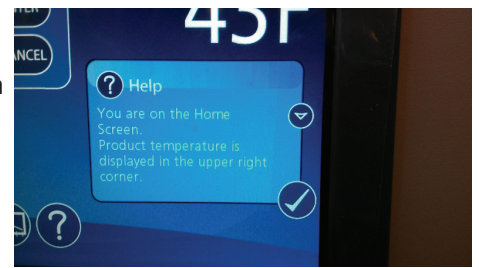







- Refrigeration Set Point 
 - Touch the number displayed in the box to the right of the Set point label and use the keypad or **UP** and **DOWN** arrows to select product temperature. Press  to accept or  to cancel.
- Sleep Temperature Display 
 - Toggle **ON** to hide the temperature reading immediately on the home screen.
- Set the Sleep Delay 
 - To automatically hide the temperature after 0-600 seconds of inactivity, touch the box to the right of the delay (0-600) box. Use keypad or **UP** and **DOWN** arrows to select from 0-600.
- Temperature 
 - Toggle between **F** and **C** to select Fahrenheit or Celsius.
- Brightness 
 - Touch the number displayed in the box to the right of the Brightness  icon and use the keypad or **UP** and **DOWN** arrows to select from 1-10. Press  to accept or  to cancel.

Fig. 14



Fig. 15



System Information



- Touch the System Info icon  to display the model number, unit serial number and software version. Touch the checkbox icon  in the lower right corner of the box to clear.

Fig. 16



Alarm or Alert Notifications



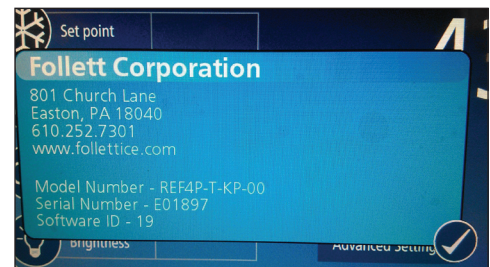

- If an alarm or event condition is detected and an alarm is engaged, an alert notification will appear in the left center of the screen with an explanation of the alert condition and a checkbox  at the bottom right of the alert box.
- No further action can be taken on the User Interface until the alert condition is acknowledged and cleared by touching the checkbox .
- Mute 
 - Touch the  icon to mute audible alarm for 10 minutes.

Fig. 17



High/Low Alarm

- This unit is equipped with a High and Low Temperature alarm that will give an audible and visual alarm immediately after the top probe falls out of range. The alarm will reappear every 10 minutes until the condition falls back into range.

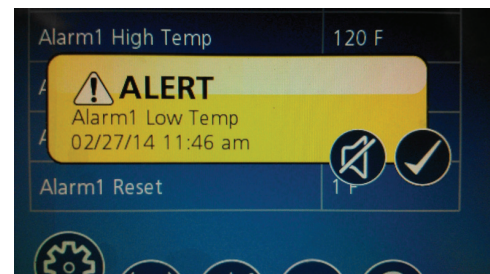
Door Switch

- This unit is equipped with a door switch that is located in the façade, and a magnet located on the top of the door. With the door closed, the switch reads closed. When the door is opened, the switch contacts open and turn on the LED lights.

Door Alarm

- This unit is equipped with a door ajar alarm that is factory set for 1 minute. In the event the door switch reads open for longer than 60 seconds (default) an audible and visual alarm will occur. The alarm will clear when the door is closed. The door alarm activation time can be changed from 0-600 seconds in the Advanced Settings Menu under Door Open Alarm Delay.

Power Alarm

- This unit is equipped with a Power Alarm that will sound if the unit loses power for more than five minutes. The Power Loss Alarm box will display every five minutes, then the screen will sleep. An audible alarm will sound every 30 seconds during the power failure. An alarm box will be displayed when power is restored. The event log will record the exact time and date of the power loss and when the power was restored.

Start-up alarm delay

This unit has a 120 minute time delay between when the unit is energized to when the temperature alarms become active. This delay can be changed in parameters in the controller under **Alarm Startup Delay**.

Setting Alarms









- Alarming Settings control the conditions and timing of event and alarm conditions that result in audible and/or visual alerts.
- To change the high alarm set point, touch the number displayed in the box to the right of the  icon and use the keypad or **UP** and **DOWN** arrows to select an alarm value. Press  to accept or  to cancel.
- To change the low alarm set point, touch the number displayed in the box to the right of the  icon and use the keypad or **UP** and **DOWN** arrows to select alarm value. Press  to accept or  to cancel.
- Audible Alarm 
 - Toggle between **ON** and **OFF** to engage and disengage the audible alarm function.
- Mute 
 - Touch the  icon to mute audible alarm for 10 minutes.

Fig. 18



Alarm Test Function

The Alarm Test Function is designed to drive the P4 reading above and below the programmed Alarm Set Points and validate the controller will signal an alarm. To perform the Alarm Test Function, follow the steps below:

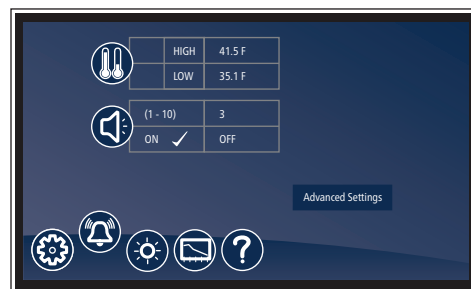
1. Press the Gear Icon
2. Locate Advanced Settings
3. Enter Code 1,1,1,1
4. Scroll to General Alarm Setup Page
5. Select Test Hi/Low Alarms- Press Test
 - Controller will slowly elevate the Alarm probe temperature above the High Alarm Value until High Alarm appears on the screen along with an audible tone.
 - Controller will slowly lower the Alarm probe temperature until it falls below the Low Alarm Value until Low Alarm appears on the screen along with an audible tone.
6. Once the Test has been completed a record of the Hi/Low Alarm test will be viewable in the Event Log with a Time/Date stamp.

Probe calibration

- NSF 456 requires the temperature display probe (P4) to be replaced or recalibrated. Follett recommends replacement/recalibration 12 months from the original date of calibration on the Certificate of Traceability supplied with your equipment at the time of purchase. Recalibration or purchasing a new calibrated probe is not covered by the original equipment warranty. To purchase a new Probe with Certificate of Traceability, please contact our Parts Department @ 1-877-612-5086 or partsales@follettice.com

The temperature probes can be offset -9.9 to $+9.9$ in the Advanced Menu settings to deliver a more precise temperature reading.

1. Select Settings
2. Select Advanced settings and enter code 1,1,1,1. Confirm with Check mark
3. Using the DOWN arrow, scroll through Advanced Settings to Calibrate screen and select Calibrate
4. Place desired probe (P1-control, P2-Defrost, P4-Top probe, P5-Bottom probe) in an ice bath and allow 3-5 minutes for temperature stabilization.
5. Press "Offset" and use the UP/DOWN arrows to offset the probe reading to the proper value.

Note: In the event of a factory reset, the offset value will return to 0.

Screen saver

The screen saver will replace the home screen and display a blank screen, time and date, or the temperature. When the screen is touched or the unit has an alarm or event, it will return to the home screen. The screen saver can be changed in the advanced setting.

Screen saver function: blank, time and date, or temperature.

Screen saver time (sec): 0—600 seconds between the last touch of the screen to the activation of the screen saver.

Information Logs

- All available graphs, data logs and event logs are accessed through the Information Logs function. The home screen in the Information Logs section displays the product (P4) temperature graph with one week's data. Date and time information is displayed on the horizontal axis.
- This unit comes factory set to display only the product temperature (P4) on the graph. All of the probes can be viewed on the graph if desired. Probes can be added to the graph through the advanced setting under DATALOG. P1 and P5(if equipped) can be added by selecting the probe and changing the parameter from No to Yes. The selected probe will now display on the graph.
 - P1 control, P4 (Top Probe), P5 (Bottom Probe)
- Zoom in (+) or Zoom out (-) on an event/temperature on the home screen will change the time scale.
- Using the left and right arrows below the graph will scroll the graph. All the stored temperature data on the graph is viewable.
- Temperature Log – to display a chronological listing of logged temperatures (latest logged temperature will display first), touch the **Temperature Log** label to the left of the screen. Use the **UP** and **DOWN** arrows to the right of the screen to scroll through the logged temperatures.
- Event Log – to display a chronological listing of events (including errors, alarms and alerts), touch the **Event Log** label to the left of the screen. Use the **UP** and **DOWN** arrows to the right of the screen to scroll through the logged temperatures.

Fig. 19

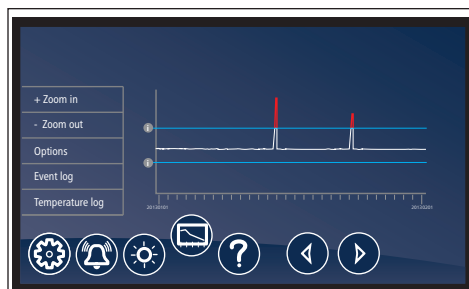
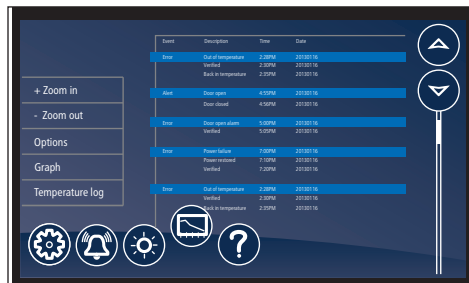

Fig. 20



Fig. 21



Data logging

- The controller is capable of storing up to 50,000 readings per probe. The factory setting for the sample rate is every 15 minutes, which will provide enough storage for 520 days. The sample rate can be change to provide data logging for a longer or shorter time interval by changing the **Sample Rate (Min)** in the advanced settings menu. **0 = off and 360 minutes maximum.**

Data Storage

- Data can be captured different ways. The factory default is for the data to overwrite itself when the memory is full. This can be changed in the advanced setting under **Data storage overwrite**. When this parameter is set to **No**, the system will display an alert when the memory is 75% full. To clear the alert the data must be downloaded.

Data duration alarm

- A reminder can be set to download the data in the **Data duration alarm** in the advanced setting. The data duration can be set from **1 to 180 days**. If the data duration alarm is used, then the **Alarm on data full** parameter in the advanced setting must also be set to **Yes**.

Downloading data

- The touchscreen has the capability of downloading the temperature data and event log via a USB port on the left side of the user interface. The file is a CSV format and is suitable for import directly into Microsoft Excel.

- Insert the storage device in the USB slot located to the left of the Touchscreen.
- Select the Graph icon along the bottom of the Touchscreen.
- Select the USB icon in the lower right hand corner.
- A yellow alert box with **downloading data** will appear.
- Press to accept or to cancel.
- After the unit is done downloading a second yellow alert box will appear asking if you want to **Erase log**.
- Press to accept or to cancel.

Note: If you chose to erase the data, the data duration timer and the data full alarm will reset. It will also erase the information that is stored on the graph.

One of the two files below will be downloaded depending on which screen is being viewed:

EL XXXX YY - Event Log

TL XXX YY - Temperature Log

XXXX = last 4 digits of serial number

YY = 0-99 number of downloaded file

Data download reminder and data full alarm

- If you plan or are required to download data for a certain time period, you can set a **download data reminder** on the Performance Plus unit. Download data reminder can be found in the advanced setting under **Data duration** and can be set from **1 to 180 days**.

Follett Keypad Lock – (Optional)

For units equipped with the electronic lock accessory option, a keypad will be displayed on the left side of the touchscreen. In order to gain access to the storage area, a user code must be entered.

- User default code is factory set to 1,2,3,4,5,6 and is stored in memory slot 01.

Fig. 22









Fig. 23



Fig. 24



Changing and Adding the User Codes

1. Touch Settings  icon.
1. Touch **Advanced Settings**, enter your 4-digit user access code (factory default is 1 1 1 1) in the keypad that appears, and touch the checkmark icon  to access advanced settings screens.
2. Time and date will be displayed. Scroll using the **UP** and **DOWN** arrows until **Change Access Code** is displayed in the Display Setup screen.
3. Touch **Change Access Code** and enter the master code [ENTER]. (By default, the master code is 1 2 3 4 5 6.)
4. Touch the screen to the right of the user code 2 to 40 to overwrite or add the user code.
5. Enter the new code. Press  to accept or  to cancel.
6. Enter the new code again. Press  to accept or  to cancel.
7. Press **DONE** when finished entering access codes.











Electronic Lock Override

- Insert key, turn lock.
- Remove panel.
- Depress plunger with screwdriver.

Light

- To turn the interior light on (or off), touch the Light icon or the Light Off icon.
- Light timer is in advanced settings.
- The light will also come on when the door is open.

Time and Date

- To set time and date, press the Settings  icon.
- To display options, touch **Advanced Settings**, enter your 4-digit user access code in the keypad that appears, and touch the checkmark icon  to access advanced settings screens (factory default is 1111).
- Time: touch displayed time and use the keypad to enter the time. Press  to accept or  to cancel.
- AM/PM: touch displayed value to toggle between AM and PM.
- Month: touch number displayed and use the keypad to enter the month. Press  to accept or  to cancel.
- Day: touch number displayed and use the keypad to enter the day. Press  to accept or  to cancel.
- Year: touch number displayed and use the keypad to enter the year. Press  to accept or  to cancel.

Advanced Settings

- Touch **Advanced Settings**, enter your 4-digit user access code in the keypad that appears, and touch the checkmark icon  to access advanced settings screens (factory default is 1111).

Fig. 25

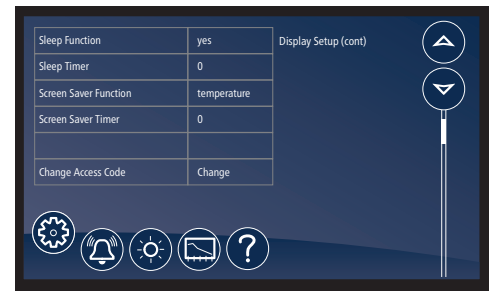

Fig. 26



Fig. 27

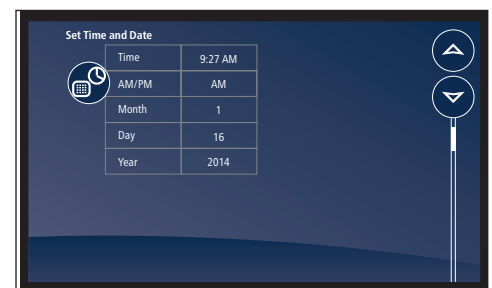

Chart recorder set up (if so equipped)

The chart recorder is mounted in the front right of the facade behind the door (**Fig. 28**). A package of 50 charts that record in C is included with your refrigerator. If you have changed your display to show temperatures in F, you will need different charts. Please call Follett at (877) 612-5086 or +1 (610) 523-9361 to order part number 00967729.

The chart recorder is powered by the controller and has its own battery back up. An LED provides battery status info: Steady green = battery okay, Flashing green = low battery or no power to the controller.

Chart recorder calibration

If desired, calibration should be done at the same time as probe calibration by pressing either the left or right arrow keys to correspond with the calibrated product display temperature.

1. Press **Left #1** or **Right #2** arrow button for 5 seconds until pen begins to move.
2. Continue to press **#1** or **#2** button to move pen to record same temperature as probe.

Changing the chart paper

1. Press and hold **#3** button until pen begins to move off chart.
2. Once the pen moves completely off chart, unscrew knob (counter-clockwise) at center of chart.
3. Remove old chart and place new chart in position so that correct time coincides with time line groove on recorder.
4. Reinstall knob.
5. Press and hold **#3** button for approximately (1) one second until pen begins to move back onto chart.
6. Make sure pen is marking paper. If not, carefully adjust arm so that pen makes contact with paper.

Replacing the pen

1. To replace pen, press and hold the **#3** button until pen starts to move off chart.
2. Once pen has moved completely off chart, carefully lift pen up and unsnap the "U" clip part to remove pen from metal pen arm.
3. Position new pen on metal pen arm and snap "U" clip underneath pen around arm to secure.
4. Press and hold **#3** button for approximately (1) second until pen begins to move back onto chart.
5. Make sure pen is marking. If not, carefully adjust arm so that pen makes contact with paper.

Removing drawers

1. Pull drawer forward to stop (**Fig. 29.1**).
2. Lift drawer front to free front rollers from slides (**Fig. 29.2**).
3. Still lifted, pull drawer forward to free back rollers from slides.

Fig. 28

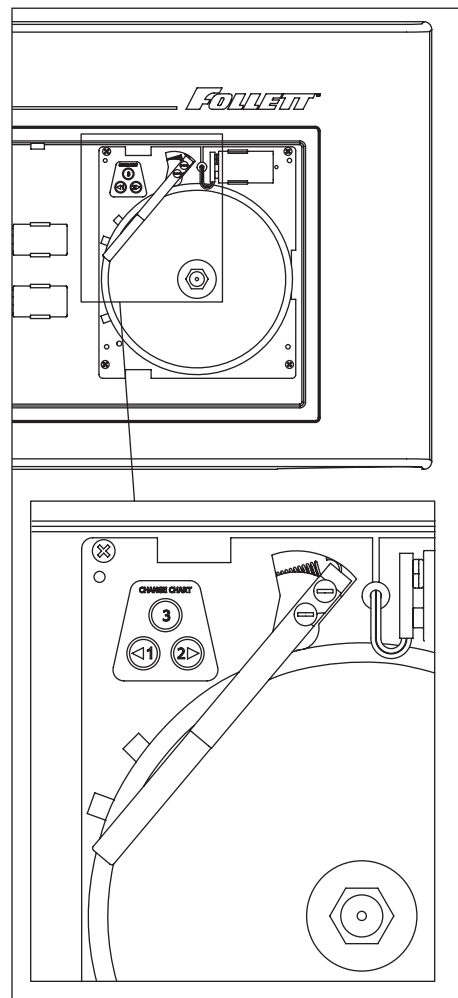
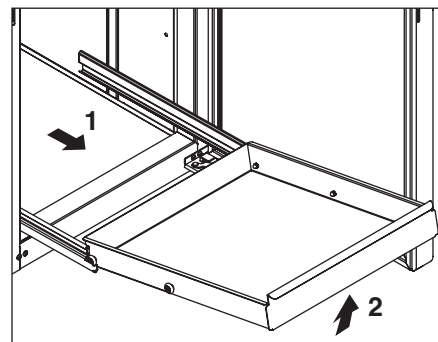

Fig. 29



Removing slides

1. Push slides all the way back.
2. Swing bottom of slide away from refrigerator wall and lift slide off rollers.

Network Enabled Device

For assistance with Network Enabled Devices, please scan the QR code. This code can also be found behind the access door on the FZR20i/25i, and on the inside cabinet wall of the FZR12i.



Scan the QR code for help with Wifi Temperature monitoring setup.



01541119R00

Rechargeable Battery

Your refrigerator is equipped with a rechargeable SLA AGM 12 V 1.2Ah battery. The unit also includes a charger which maintains battery charge in readiness of a potential power failure event.

|  CAUTION | |
|--|---|
|  | <ul style="list-style-type: none">▪ Risk of hazard if non-rechargeable or otherwise improper battery is installed in the system.▪ If battery maintenance is required, use only appropriate Follett-authorized service part or compatible SLA AGM 12 V 1.2Ah battery. |

Cleaning

Use non chlorine-based cleaners. Cleaners containing chlorine can cause staining and pitting of the stainless steel.

Disconnect power to unit by turning the power switch off, located on the upper front facade panel, and removing the power cord from the receptacle.

Interior cleaning

Using a sponge or soft cloth, clean unit with a non-abrasive, non-chlorinated, all-purpose detergent. Note: The air plenum should be removed to clean it, as well as behind it (**Fig. 30, 31**). In addition the shelves, baskets, drawers and slides should be cleaned as well.

Exterior cleaning

Wipe stainless steel exterior with a soft cloth in the direction of grain as needed. Stainless steel polish may be used to enhance the finish of the unit. The glass door and exterior parts may be cleaned with a soft cloth, window cleaner or other non-abrasive cleaner.

Fig. 30

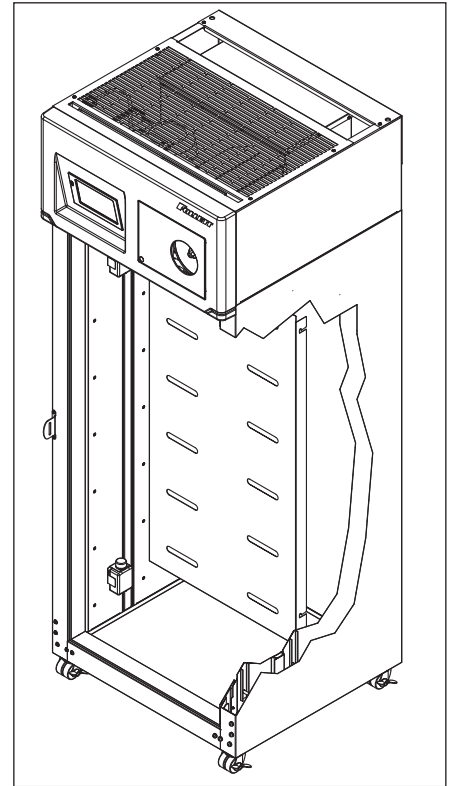
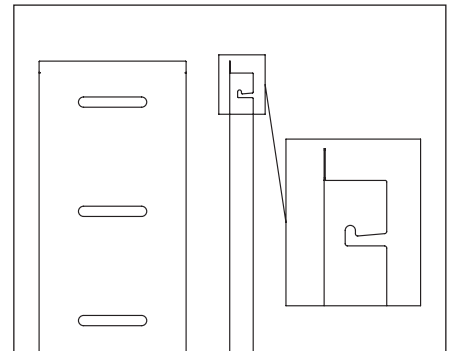

Fig. 31



Annual cleaning

Removal of dust and other particulates from air intake areas and the condenser is important for proper operation. Environments with large amounts of dust may require more frequent cleaning.

1. Disconnect power to unit by turning power switch off (located on upper front facade panel) and removing power cord from receptacle.
2. The condenser can be accessed from top for cleaning. The side panel in front of condenser may be completely removed for easier cleaning by disconnecting facade and removing upper side panel. See Facade Removal for facade removal instructions.
3. Inspect drain pan for any debris or obstruction in condensate pan (**Fig. 32.1**).
4. Use a vacuum cleaner with brush attachment to clean condenser, compressor and related parts.
5. Reinstall upper side panel and facade if removed.

Fig. 32

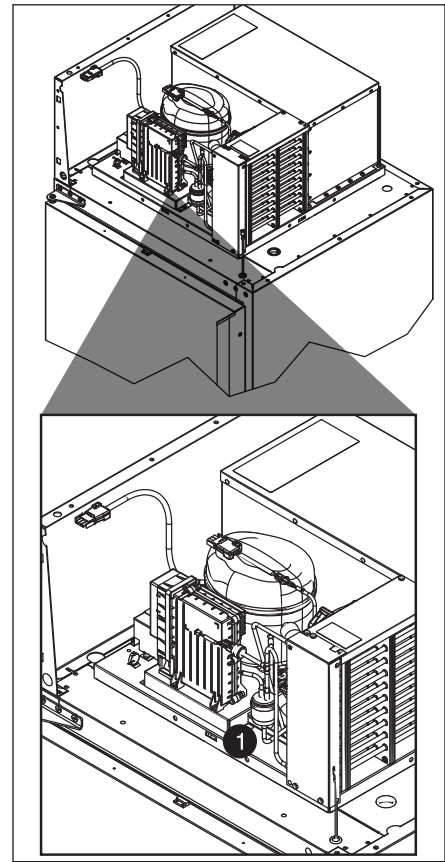

Defrosting

The FZR20i/25i series upright freezers control frost accumulation on the evaporator through automatic timed defrost cycles. The evaporator defrosts automatically every 6 hours. The evaporator face mount heater, drain pan heater, and condensate drain line heater energize and any accumulated ice on the evaporator and evaporator drain pan melts and drains out the drain line to the condensate pan located under the compressor. Defrosting will display on the main screen above the product temperature button. Defrost terminates when either 30 minutes has elapsed or the evaporator temperature reading from the defrost probe (P2) reaches 5.0 C (41 F).

Folletts Patented P.I.D. Controller

Folletts patented P.I.D. controller allows the control system to modulate the RPMs of the compressor and condenser fan according to cabinet requirements. The evaporator fan runs at a consistent RPM value during cooling system operation.

Proportional Control Operation - Primary

As the return air (P1 probe) reading rises above the set point value, the compressor and condenser fan RPMs increase to provide additional cooling capacity.

As the return air (P1 probe) value approaches set point, the compressor and condenser fan RPMs reduce.

As the return air (P1 probe) reading falls below the set point, the compressor and condenser fan RPMs will operate at minimum levels to sustain product and cabinet temperature.

The compressor and condenser fan RPMs will continue to increase and decrease to sustain desired set point.

Integral Control Operation - Secondary

As a secondary to the Proportional Control, the Integral Control Operation also analyzes the amount of time that the return air (P1-Control) has been above or below set point value. In tandem with the Proportional Control, it adjusts compressor and condenser RPMs to sustain cabinet temperature.

Derivative Control Operation - Tertiary

As a tertiary control function, the Derivative Control Operation monitors return air (P1-Control) specifically identifying sudden increases and decreases in return air temperature and, when identified, will adjust RPMs accordingly.

| ATTENTION |
|--|
| <i>Cabinet temperature adjustments can be made by simply modifying the temperature control setpoint. Modifications to the factory default settings will result in excessive compressor cycles and may lead to premature failures. Component failures caused by adjusting critical control parameters may void the equipment warranty.</i> |

Sensor Readings/Temperature Display

The Touchscreen is defaulted to display the P4-Top probe which reads the solution temperature of your product simulation bottle. For ease of troubleshooting, the Touchscreen can be toggled to display the P1-control probe to view the refrigeration cycle. To toggle the display for your desired probe, Access Advanced Settings>Display Probe and select the desired probe.

Note: After service is complete it is recommended to restore the display to the P4-Top Probe.

Fascia Heater

Factory default for the fascia heater cycle is set to 75%, based on a 20 minute cycle (e.g. 75% = 5 minutes off, 15 minutes on).

Should the need arise, the door schedule can be changed in Advanced Menu>Door Heater.

Facade removal

⚠ CAUTION



- The following terminals are hazardous live:
 - PWR IN
 - Inverter/Comp
 - Defrost Heater
 - Door Heater
 - (45) Door Heater

1. Locate the façade door to the right of the controller display. Press and release the lower left corner of the façade door to open. Locate ON/OFF switch and turn to OFF position.
2. Remove top ventilation cover.
3. Disconnect all wiring harnesses attached to the rear of the façade.
4. Open refrigerator door and locate the two screws on the underside of the façade. Remove and retain screws.
5. Gently pull the plastic façade cover forward approximately 1.5", separating the bayonet mounts from the sides of the side support panels (**Fig. 33**).

Fig. 33

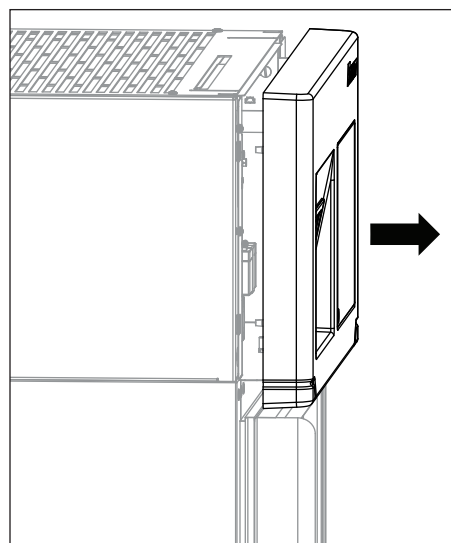

6. Lift and pivot the bottom of the façade upwards to just above horizontal, and allow it to track on the façade hinge (**Fig. 34**).

Fig. 34

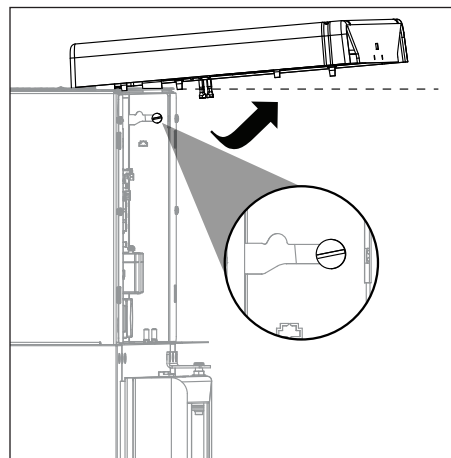

7. Slide the façade hinge towards the rear of the cabinet allowing the hinge pin to slide within the groove until the top male bayonet pin rests on the top of the electrical control box (**Fig. 35**).
8. Continue sliding front façade towards back of cabinet, until it rests entirely on top of unit.

Fig. 35

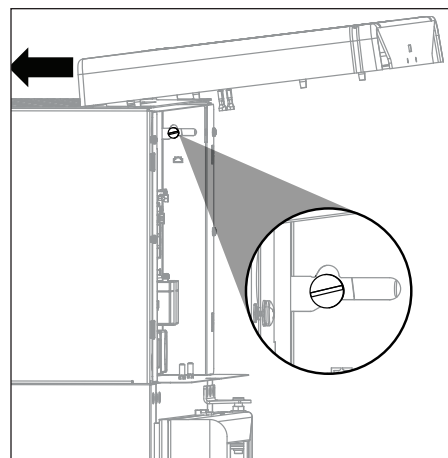

9. Remove two screws on both the left and right side that secure the electrical control box to the side support panels (**Fig. 36**).
10. Carefully grab the plastic front façade and bring it down to meet the rear of the façade.
11. While holding the front of the façade, grip the rear façade left/right tabs and entirely remove from cabinet.
12. Carefully close façade.
13. Reinstall vertical screws through façade cover.
14. Pull façade assembly away from cabinet.

Fig. 36

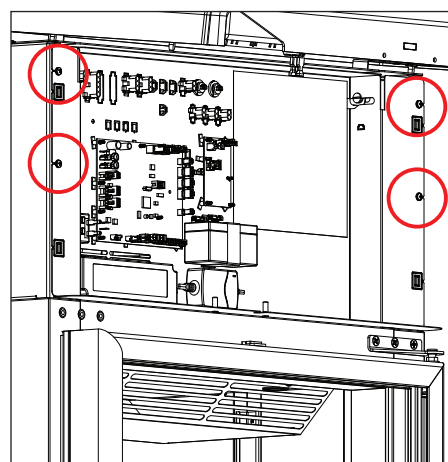

Controller replacement

| | |
|---|--|
| ⚠ CAUTION | |
|  | <ul style="list-style-type: none">• Controller board is susceptible to electrostatic discharge. Extreme care should be exercised by using a grounding strap when handling and installing control board. |

1. Turn off power to unit and unplug.
2. Disconnect electrical plugs and remove facade.
3. Remove screw securing ground screw to refrigerator cabinet (**Fig. 37.1**). Do not remove ground wire from facade.
4. Place facade face down on flat clean surface with bottom of facade facing you, and remove four screws attaching back panel to facade.
5. Lift and rotate back panel toward you.
6. Take precautions for proper grounding to reduce risk of electrostatic discharge (ESD) to the controller board.
7. Locate the control board standoffs (**Fig. 37.2**).
8. Using Needle nose pliers, pinch the stand-off tabs and gently pull up on the control board to release.
Note: All wiring should remain connected to the original control board at this time.
9. Install replacement control board on existing stand-offs.
Note: Use supplied stand-offs to replace any that may have been damaged during control board removal.

10. Removing one at a time, transfer wiring from the original control board to the replacement control board, ensuring each wire is secured at the same location it was removed from.
11. Flip façade cover back into position on façade and reinstall 4 screws.
12. Remount façade to bayonet mounts.
13. Reconnect ground wire to grounding location on cabinet.
14. Reconnect all electrical and probe connections.
15. Plug in unit and power on, ensuring proper operation.

Fig. 37

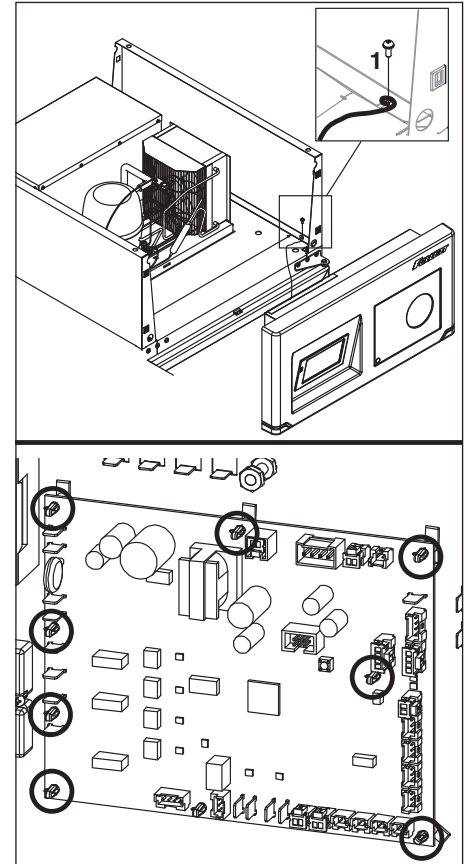

Reversing the door swing (requires a new door)

FZR20i/25i units ship standard with a non heated right hinged door. To change to a left hinged configuration requires a new door. For heated door options other parts may be required. If the unit has a heated door option consult technical service by calling (877) 612-5086 or +1 (610) 252-7301.

Door gasket replacement

1. Remove existing gasket from mounting track (**Fig. 38**).
2. Verify mounting track is free of any remaining gasket material.
3. Align new gasket with mounting track and press firmly in place.
4. Open and close door, checking for proper gasket seal without pinching against refrigerator.

Fig. 38

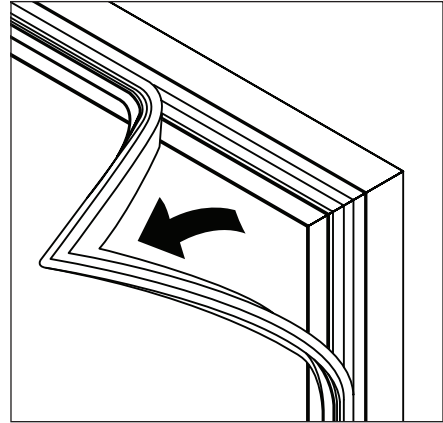

Slide-out unit cooler

Follett's slide-out refrigeration system allows technicians to remove the entire unit from the refrigerator top.

1. If necessary remove facade and upper side panels.
2. Remove four bolts securing unit cooler to refrigerator top (**Fig. 39**).
3. Gently lift off cooler.

Fig. 39

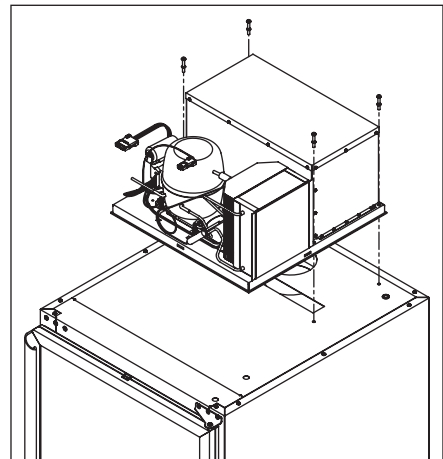

Refrigeration System

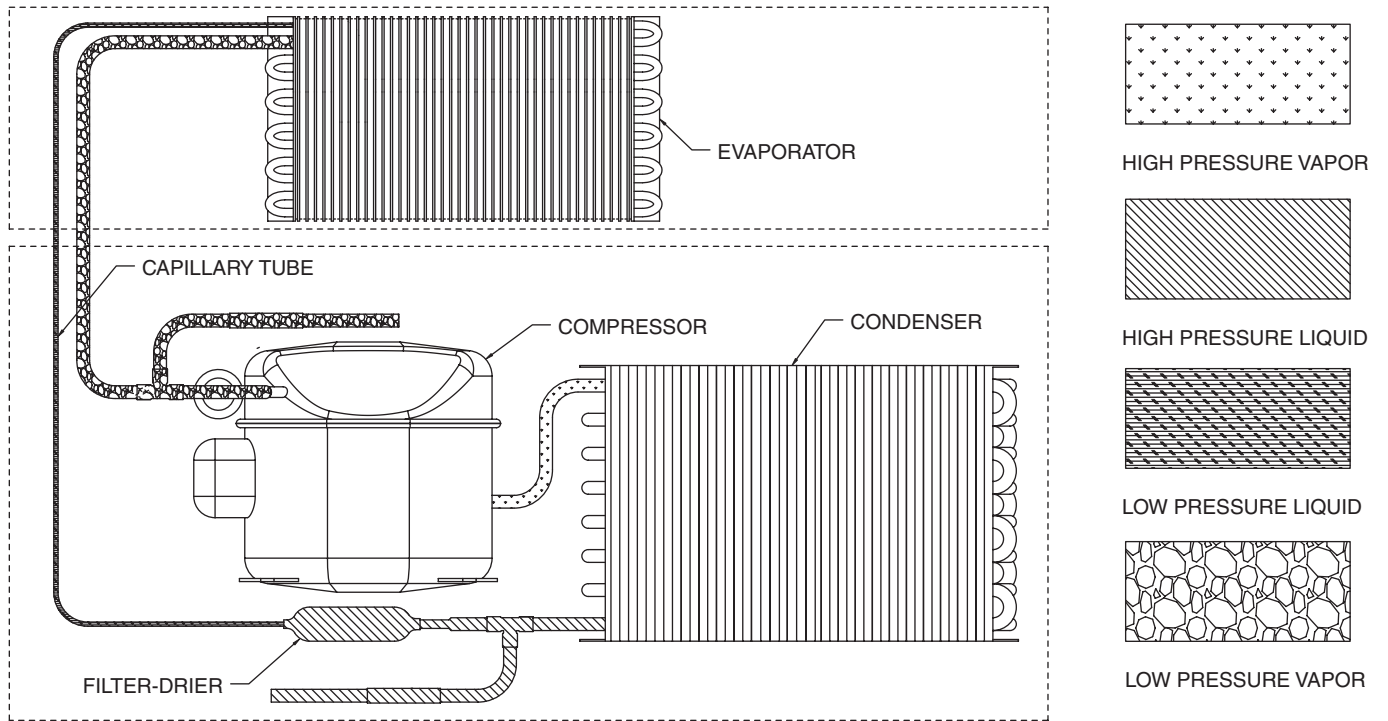

Advanced Setting - touchscreen

| Parameter | Default Value | Range | Description |
|----------------------------|---------------|------------------------------------|---|
| Set Time and Date | | | |
| Time | 7:45 | 0 to 12 | Holds Hour |
| AM/PM | AM | AM, PM | Holds AM/PM |
| Month | 12 | 1 to 12 | Month |
| Day | 16 | 1 to 31 | Day |
| Year | 2013 | 2010 to 2099 | Year |
| System Information | | | |
| Serial Number | E12345 | — | — |
| MC Version | 33 | — | MC version |
| UI version | 17 | — | UI version |
| Display Setup | | | |
| Beeper Function | ALL | Off, All, dr, Alr, Err | Controls the audible beeper function on the controller. Off (all off), All (all on), Door (dr), Alarm (Alr), Error (Err). |
| Beeper Volume | 5 | 0 to 10 | Beeper. |
| Button Clicks | Yes | Yes, No | Sets if a beep should sound each time a button is pressed. |
| Display Probe | RTD1 (P4) | Control (P1), Defrost (P2), P4, P5 | The probe to display on controller. |
| Resolution | Dec | Int, Dec | Integer or decimal |
| Sleep Function | Yes | Yes, No | Sleep function will blank the screen after 0 to 600 seconds of non-use. |
| Sleep Timer | 0 seconds | 0 to 600 seconds | Amount of time before the screen blanks automatically. |
| Screen Saver Function | Temperature | Blank, temperature, date/time | Screen saver function will hide the home screen. It will display a blank screen, temperature, or time and date. |
| Screen Saver Timer | 0 seconds | 0 to 600 seconds | Amount of Time before the screen saver initiates. |
| Change Keypad Access Code | Change | — | Allows entry/editing of keypad access codes. Password required. |
| Control Setup (FZR) | | | |
| User Set Point | -30 C (-22 F) | LSP-USP | The temperature setpoint that the user adjusts. |
| Upper Setpoint | 10 C (50 F) | — | Upper range of user-adjustable setpoint. |
| Lower Setpoint | 2 C (36 F) | — | Lower range of user-adjustable setpoint. |
| Lock Setpoint Adjustment | Unlocked | Unlocked, locked | Locks the setpoint C/F, and alarm high/alarm low against accidental changes. |
| Import Parameters | No USB drive | No USB, import parameters | Import parameters from a USB port. |
| Export Parameters | No USB drive | No USB, export parameters | Export parameters from a USB port. |
| Keypad Present | No | Yes, No | Defines if product has keypad door lock. |
| PID Time Interval | 10 | 1 to 120 seconds | Time interval between changes in compressor and fan speeds. |
| AntiFreeze Enable | Yes | Yes, No | Determines whether the AntiFreeze function is enabled. |
| AntiFreeze Temp | 2 C (36 F) | 30 to User Set Point | Determines temperature at which AntiFreeze will activate. |
| AntiFreeze Delay | 0 | 0 to 240 seconds | Once P4 reaches AntiFreeze Temp, amount of time to wait before activating AntiFreeze function. |

| Parameter | Default Value | Range | Description |
|-----------------------------|----------------|-----------------------------|--|
| Alarm Setup | | | |
| Alarm 1 Delay | 1 minute | 0 to 60 minutes | Alarm1 delay before sounding. |
| Alarm 1 Function | rA | No, rA, disabled | Defines the action when Alarm 1 is activated. Display only (No), Display and Remote Alarm (rA), No action (disabled). |
| Alarm 1 High Temp | 8 C (46 F) | User Set Point to 150 | High temperature to activate Alarm 1. |
| Alarm 1 Low Temp | 2 C (36 F) | -50 - User Set Point | Low temperature to activate Alarm 1. |
| Alarm 1 Probe | Alarm (P4) | RTD1, airReturn, evaporator | Probe for Alarm 1. |
| Alarm 1 Reset | 1 | 0 to 10 | Temperature difference to reset Alarm 1. |
| General Alarm Reset | | | |
| Alarm Ringback | 10 minutes | 0 to 120 minutes | Defines the time delay until the alarm will resound. |
| Alarm Startup Delay | 120 minutes | 0 to 180 minutes | Defines the alarm delay during startup. |
| Alarm Silencing | Yes | Yes, No | Determines if the alarms can be silenced or not. |
| Maintain Alarm | Yes | Yes, No | Determines if the alarm should be maintained if the temperatures fall back into range. |
| Test Hi/Lo Alarm | Test | - | Initiate a simulated High and Low alarm test. |
| Test Alarm | Test | - | |
| Door Control | | | |
| Door Open Alarm | Yes | Yes, No | Sound beeper when door alarm activated. |
| Door Open Alarm Delay | 60 seconds | 0 to 300 seconds | Door open alarm delay. |
| Door Open Remote Alarm | rA | RTD1, airReturn, evaporator | Defines action when door open alarm activated. Display only (No), Display and Remote Alarm (rA), No action (disabled). |
| Door Fan control | Yes | Yes, No | Defines if the evap fan should shut off when the door is open. |
| Door compressor time | 200 seconds | 0 to 300 Seconds | Defines the time to shut off the compressor after the door is open. 0 = ignore |
| Light control | | | |
| Turn light on/off with door | Yes | Yes, No | Turn light on/off with door openings. |
| Light off timer | 120 seconds | 0 to 600 Seconds | Turn off the light after XX seconds |
| LED Light Control | LEDLightMosfet | - | LED output designation. |
| Power Alarm | | | |
| Power Alarm | Yes | Yes, No | Defines if an alarm should sound if power is lost. |
| Power Remote Alarm | Yes | Yes, No | Defines if remote alarm should activate on power alarm. |
| Power Alarm Timer | 5 minutes | 0 to 120 minutes | Delay before sounding the power alarm. |
| Battery Level | | | Battery Level |
| Battery Backup | Rechargeable | Rechargeable, Standard | Determines if type of backup battery is rechargeable or standard. |
| Recharge Delay | 120 | 0 to 300 seconds | When |

| Parameter | Default Value | Range | Description |
|------------------------------|---------------|--|---|
| Data log | | | |
| Sample Rate | 15 minutes | 0 to 360 minutes | minutes between data sampling. 0 = Off |
| Data Duration | 90 days | 1 to 180 days | Duration to keep data log. |
| Data Storage Overwrite | Yes | Yes, No | Overwrite circular data? |
| Data Full Alarm | No | Yes, No | Alarm when data memory is full? |
| Track Events | Yes | Yes, No | Track events with log |
| Display System Events | Yes | Yes, No | Determines if non-alarm system events are shown in the event log. |
| P1 Datalog | No | Yes, No | Log P1 to event log |
| P2 Datalog | No | Yes, No | Log P2 to event log |
| P3 Datalog | No | Yes, No | Log P3 to event log. |
| P4 Datalog | Yes | Yes, No | Log P4 to event log |
| P5 Datalog | No | Yes, No | Log P5 to event log |
| RPM Datalog | No | Yes, No | Log Compressor RPM to event log. |
| CFan Datalog | No | Yes, No | Log Condenser Fan PWM percent to event log. |
| EFan Datalog | No | Yes, No | Log Evaporator Fan PWM percent to event log. |
| Defrost | | | |
| Manual Defrost | Initiate | – | Force the unit into a defrost |
| Defrost Function | PowerOn | PowerOn, CompressorOn, TimeOfDay, ManualOnly, Disabled | Defines tactic for initiating a defrost |
| Defrost Tactic | ElecHeat | Evaporator, ElecHeat, HotGas | Defines type of defrost. |
| Defrost Termination Tactic | Temperature | Temperature, Duration | Defines defrost end routine. |
| Defrost Timer | 6 | 2 to 720 hours | Time between defrost cycles. |
| Defrost Termination Temp | 41 | 0 C to 66 C (32 F to 150 F) | When termination tactic is set to Temperature, defines this temperature. |
| Defrost Duration | 30 | 0 to 60 minutes | When termination tactic is set to Duration, defines this duration. |
| Evap Fan Defrost Delay | 0 | 0 to 500 seconds | After a defrost concludes and drip time concludes, amount of time to delay restart of evap fan. |
| Drip Timer | 0 | 0 to 300 seconds | After defrost concludes, amount of time to delay restart of compressor and condenser fan. |
| Evap Fan Restart | Time | Time, Temperature | Defines if evap fan should restart based on time or temperature at the conclusion of a defrost cycle. |
| Evap Fan Temp | 30 | -40 C to 15 C (-40 F to 60 F) | After defrost concludes and drip time concludes, temperature to reach before restart of evap fan. |
| Evap Fan Defrost PWM Percent | 50 | 0% to 100% | Defines fan speed during an evaporator fan defrost. |

| Parameter | Default Value | Range | Description |
|-------------------------|--|-----------------------------|--|
| Graphing | | | |
| X Axis Range (hrs) | 168 hours | 1 to 384 hours | Time span for x-axis |
| Y Axis Minimum | -1 C (30 F) | -46 to 121 C (-50 to 250 F) | Minimum temperature shown on graph |
| Y Axis Maximum | 27 C (80 F) | -46 to 121 C (-50 to 250 F) | Maximum temperature shown on graph |
| Graph Show Alerts | No | Yes, No | Determines whether alerts are displayed on the graph |
| P1 Graph Display | NO | Yes, No | Determines whether to graph probe 1 |
| P2 Graph Display | No | Yes, No | Determines whether to graph probe 2 |
| P3 Graph Display | No | Yes, No | Determines whether to graph probe 3 |
| P4 Graph Display | No | Yes, No | Determines whether to graph probe 4 |
| P5 Graph Display | No | Yes, No | Determines whether to graph probe 5 |
| Door Heater | | | |
| Door Heater | UR FZR with Heated Glass Door: Yes All others: No | Yes, No | Controls door heater output |
| Door Heater Off (mins) | UR FZR with Heated Glass door: 10 | 0 to 100 | Off time for door heater if dht = on |
| Door Heater On (mins) | UR FZR with Heater Glass door: 10 | 0 to 100 | On time for door heater if dht = on |
| Door Heater Threshold | 50 | 0 C to 49 C (32 F to 120 F) | Control probe temperature below which the door heater function is engaged. |
| Probes | | | |
| Probe Error | BPr | NO, BPr, R1 relay, R2 relay | Action to take when probe error detected |
| Control On Time (mins) | UR FZR: 4 | 0.0 to 120.0 minutes | Compressor on time when control probe error (minutes) |
| Control Off Time (mins) | UR FZR: 8 | 0.0 to 120.0 minutes | Compressor off time when control probe error |
| Probe Calibration | Calibrate | | Calibrate probes through a second menu |
| Viewable | | | |
| Probe Readings | View | | View current temperature value of probes 1-5. |
| Power On Time (hrs) | | | View cumulative hours that the unit was in service |
| Compressor cycles | | | The number of compressor starts |
| Toal Comp Time (hrs) | | | View cumulative hours that the compressor was energized |
| Compressor RPM | | | Current compressor speed (RPM). |
| Cond Fan PWM Percent | | | Current condenser fan speed (%). |
| Evap Fan PWM Percent | | | Current evaporator fan speed (%). |
| PPIDCC View | | | View detailed control parameters. |

| Parameter | Default Value | Range | Description |
|--------------------------|---------------|-------------------------------|---|
| Software | | | |
| Reset | No | Yes, No | Set to Yes to reset all parameters back to factory default. Does not change keypad codes. |
| Change Adv Settings Code | Change | | Change the digit code used to access the advanced settings menu. |
| Download Log File | | | Downloads system log to a USB drive. |
| Keypad Access Log | | | Downloads keypad log to a USB drive. |
| Erase Data Log | Erase | | Clears the contents of the data log. |
| Software Update | Update | | Updates the touchscreen software and main control board software. |
| Analog Out | | | |
| Analog Out 1 | P4 | P1, P2, P3, P4, P5, 5vdc | Defines which probe should be tracked with analog out, or set to constant 5 VDC. |
| Analog Upper Range | 25 C (77 F) | -1 C to 38 C (30 F to 100 F) | Upper limit for analog output. |
| Analog Lower Range | -5 C (23 F) | -45 C to -2 C (-50 F to 29 F) | Lower limit for analog output. |
| Analog Battery Power | Yes | Yes, No | Determines if analog output should be powered during a loss of AC power. |
| Advanced Setup | | | |
| Probe 1 Presence | Yes | Yes, No | Defines if Probe 1 is present. |
| Probe 2 Presence | Yes | Yes, No | Defines if Probe 2 is present. |
| Probe 3 Presence | No | Yes, No | Defines if Probe 3 is present. |
| Probe 4 Presence | Yes | Yes, No | Defines if Probe 4 is present. |
| Probe 5 Presence | No | Yes, No | Defines if Probe 5 is present. |
| Input 1 Config | DoorOpen | DoorOpen, HPS, Disabled | Defines Input 1. |
| Input 2 Config | HPS | DoorOpen, HPS, Disabled | Defines Input 2. |
| Network Device Present | Yes | Yes, No | Determines if the Network Interface Device is present. |
| Bluetooth Enabled | Yes | Yes, No | Determines if the Bluetooth signal is enabled. |

Replacement parts

Unit cooler (Embraco - Black Evaporator Cover)

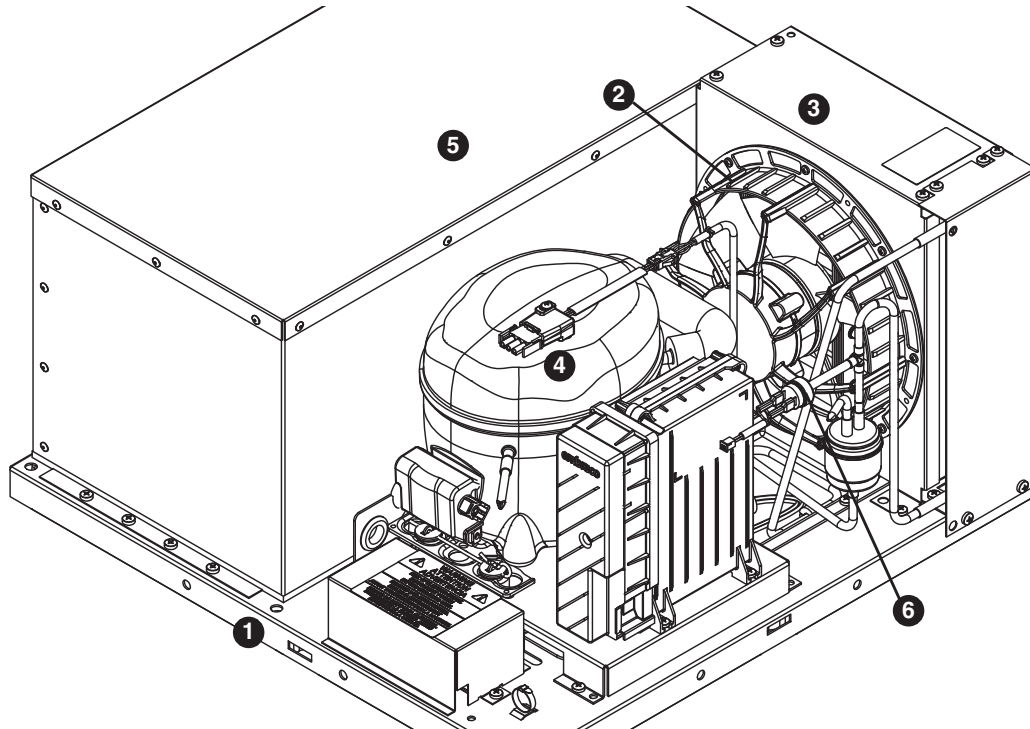

| Reference | Description | Part # |
|-----------|---|----------|
| Not shown | Gasket, unit cooler | 00912980 |
| Not shown | Probe, NTC, air return/evaporator | 01552496 |
| 1 | Cooling module, Infinity Series freezer, includes mounting bolts and gasket | 01550870 |
| Not shown | Evaporator fan, 24 Vdc, variable speed | 01539733 |
| 2 | Condenser fan, 24 Vdc, variable speed | 01552546 |
| Not shown | Filter drier | 01565241 |
| 3 | Condenser with drier | 01334101 |
| 4 | Compressor, Infinity Series freezer, includes drier | 01539717 |
| 5 | Evaporator with drier | 01350065 |
| 6 | Pressure switch and drier | 01552538 |
| Not shown | Cord and plug kit | 00939900 |
| Not shown | Hose, condensate drain | 01334036 |
| Not shown | Condensate pan | 01334093 |
| Not shown | Cover, evaporator | 01334242 |
| Not shown | Inverter with power and serial cable | 01569086 |
| Not shown | Harness, power | 01569094 |
| Not shown | Heater, condensate | 01569110 |
| Not shown | TXV and drier | 01569136 |
| Not shown | Cable, evaporator condenser fan | 01569144 |
| Not shown | Cable, high-pressure switch | 01569151 |
| Not shown | Cable, serial connection | 01569169 |

Facade

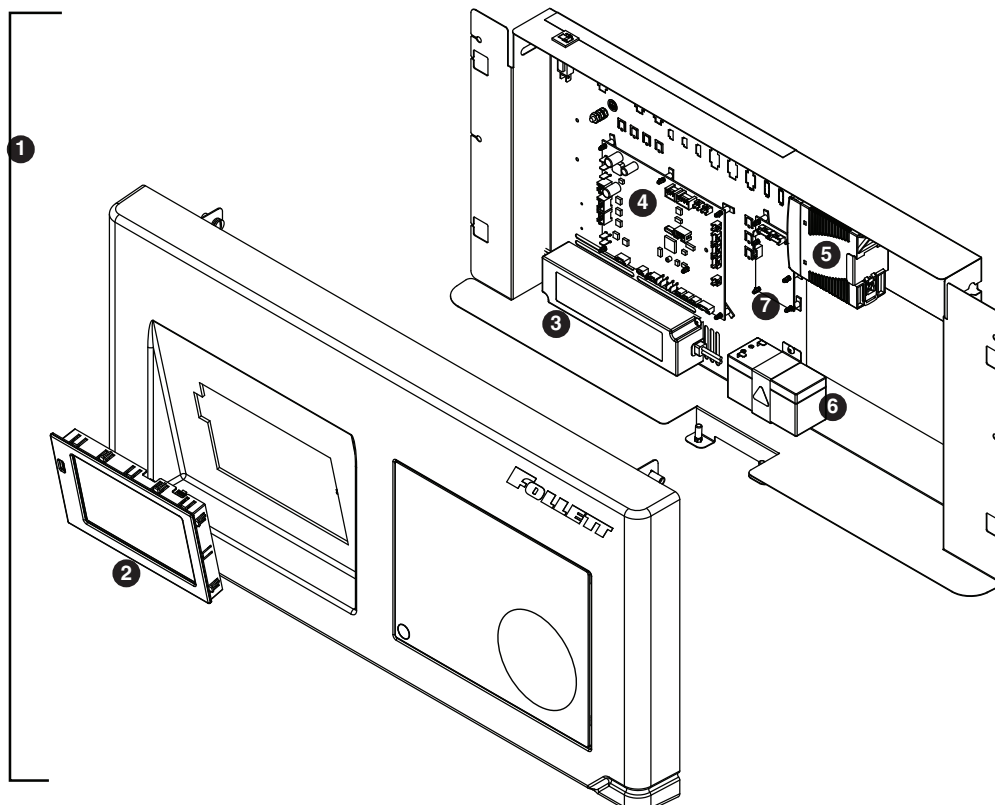

| Reference | Description | Part # |
|-----------|---|----------|
| 1 | Complete facade/control box assembly, without chart recorder | 01564574 |
| Not shown | Complete facade/control box assembly, with chart recorder | 01564566 |
| 2 | Infinity Series Touchscreen display | 01564558 |
| Not shown | Power switch | 502209 |
| 3 | Power supply (LEDs, condenser fan, evaporator fan), 100W, 24 Vdc output | 01552215 |
| 4 | Infinity Series control board | 01564541 |
| 4 | Infinity Series control board, with chart recorder | 01564533 |
| 5 | Battery charger, 12 Vdc | 01552181 |
| Not shown | Door switch/facade reed switch (does not include magnet) | 01132091 |
| Not shown | Harness, main ac power | 01552207 |
| Not shown | Cable, 3 wire, compressor communication signal, board-to-panel | 01552173 |
| Not shown | Cable, evaporator/condenser fan, board-to-panel | 01552165 |
| Not shown | Cable, LEDs, board-to-panel | 01552157 |
| Not shown | Cable, board to power switch | 01552140 |
| Not shown | Harness, chart recorder, Infinity Series | 01552298 |
| Not shown | Harness, board to touchscreen | 01064856 |
| Not shown | Harness, electronic lock, board-to-panel | 01026848 |
| Not shown | Chart recorder | 00906198 |
| Not shown | Chart recorder pens, box of 6 | 00918813 |
| Not shown | Chart paper, degrees C (box of 50) | 00918821 |
| Not shown | Chart paper, degrees F (box of 50) | 00967729 |
| Not shown | Bayonet clip, male | 00179549 |
| Not shown | Bayonet clip receptacle, female | 00179556 |
| 6 | Battery, 12 V rechargeable | 01552199 |

| Reference | Description | Part # |
|------------------|--|--------------------------|
| 7 | RTD board (BB models only) | 01143965 |
| Not shown | Shell, upper side, FZR25i | 00940098 |
| Not shown | Shell, upper side, FZR20i | 00925933 |
| Not shown | Top ventilated cover | 01519040 |
| Not shown | Back support | 00991695 |
| Not shown | Harness, RTD probe, JST connectors, board-to-panel | 01529098 |
| Not shown | Harness, NTC probe, board-to-panel | 01132075 |
| Not shown | Latch fastener | 00901165 |
| Not shown | NIC card | 01279686 |
| Not shown | Harness, FZR defrost | 01564525 |
| Not shown | 8A circuit breaker | 00128090 |

Door assembly

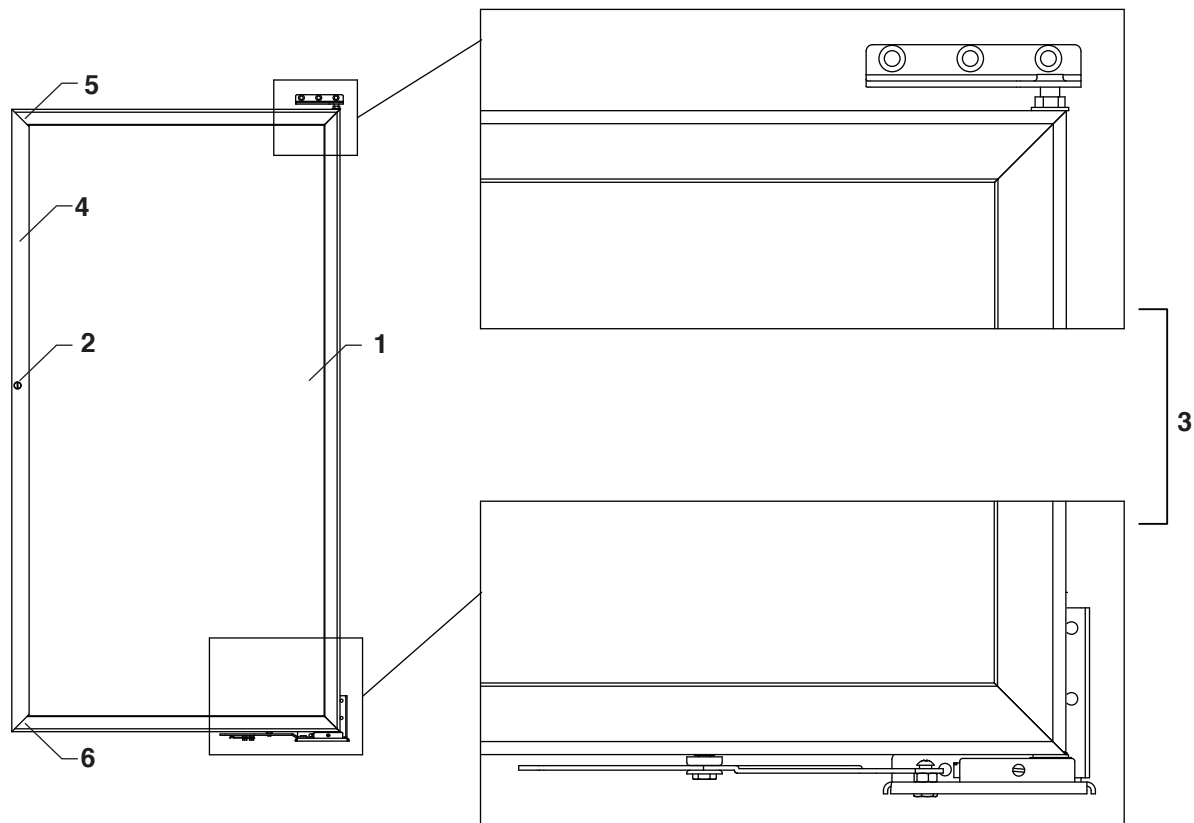

| Reference | Description | Part # |
|-----------|---|----------|
| Not shown | Door gasket, solid door | 00960344 |
| Not shown | Solid door, left-hand hinge | 00996611 |
| 1 | Solid door, right-hand hinge | 00996603 |
| Not shown | Key, solid door | 01035013 |
| 2 | Lock, solid door | 00996629 |
| Not shown | Lock bracket | 00939983 |
| Not shown | Door magnet kit (does not include facade reed switch) | 00939967 |
| 3 | Right-hand hinges with hardware | 00996579 |
| Not shown | Left-hand hinges with hardware | 00996587 |
| Not shown | Soft port kit | 00940122 |
| 4 | Solid door handle | 00996637 |
| 5 | Molded door handle cap, top | 00989251 |
| 6 | Molded door handle cap, bottom | 00989244 |
| Not shown | Seismic anchoring wall bracket | 00927194 |
| Not shown | Pyxis bracket kit | 00927202 |
| Not shown | Omicell bracket kit | 00966432 |
| Not shown | Electronic lock | 01065507 |
| Not shown | Electronic lock bracket with screws | 01278563 |
| Not shown | Electronic lock door bracket | 01151547 |
| Not shown | Electronic lock cover | 01289990 |

| | | |
|-----------|--------------------------------------|----------|
| Not shown | KP ready solid door handle | 01152065 |
| Not shown | Solid door, KP ready, RH with hinges | 01152149 |
| Not shown | Solid door, KP ready, LH with hinges | 01152131 |
| Not shown | Adjuster, TorqueMaster | 00984229 |

Cabinet

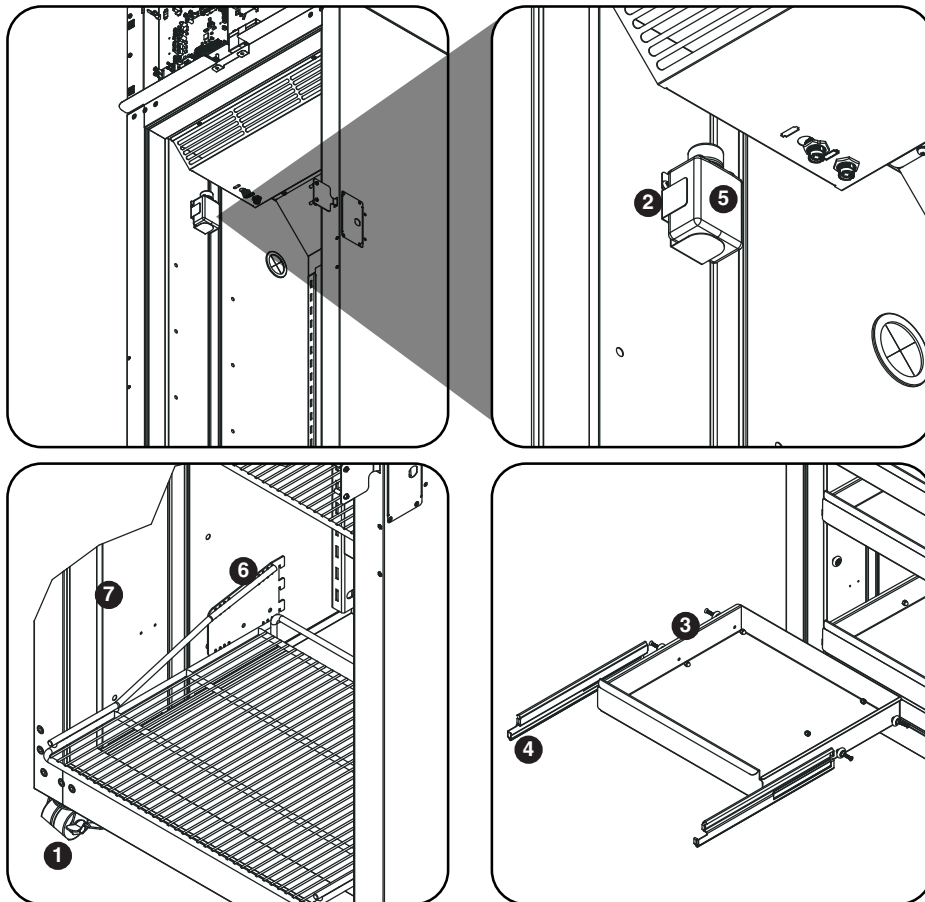

| Reference | Description | Part # |
|-----------|--|----------|
| 1 | Caster, swivel with brake | 00187674 |
| 2 | Bracket for 125 ml bottle (BB models only) | 00171132 |
| 3 | Drawer, assembly, FZR25i | 01554492 |
| 3 | Drawer, assembly, FZR20i | 01554500 |
| 4 | Slide, drawer, FZR25i (set of 2) | 00193045 |
| 4 | Slide, drawer, FZR20i (set of 2) | 00188367 |
| 5 | 125 ml bottle with gasket (BB models only) | 01015817 |
| Not shown | Basket, assembly, FZR25i | 01548833 |
| Not shown | Basket, assembly, FZR20i | 01548825 |
| 6 | Shelf, FZR25i | 01548817 |
| 6 | Shelf, FZR20i | 01548809 |
| Not shown | Temperature probe, top, NIST calibrated | 01540640 |
| Not shown | Temperature probe, bottom, NIST calibrated | 01540541 |
| 7 | Cover, thermal break (4 pieces) | 00922997 |
| Not shown | LED, light strip | 00980912 |
| Not shown | Wire clip, probe | 00919910 |
| Not shown | Glycerine (1 pint) | 00959296 |
| Not shown | 60 ml bottle with gasket and bracket | 01053792 |

Warranty Registration and Equipment Evaluation

Thank you for purchasing Follett Products LLC equipment. We hope you find that our equipment meets or exceeds your expectations, as our goal is to deliver high value products and services that earn your complete satisfaction!

Please review the enclosed installation and operations manual. It is important that the installation be performed to factory specifications, so your equipment operates to its maximum efficiency.

Follett Products LLC will not be liable for any consequential damages, expenses, connecting or disconnecting charges or any losses resulting from a defect of the machine.

For full warranty details, visit our website www.follettice.com/productwarranties.

Warranty registration and equipment evaluation is important to help us keep track of our equipment and to record the machine's performance.

We request that you register Follett equipment warranties on our website www.follettice.com/support and choose Warranty Registration and Equipment Evaluation. It's simple to do; please take a moment to register today. There is also space on the form to provide us with comments and feedback. Please let us know about your experience so we can capture it for our continuous improvement efforts.

We pride ourselves on producing outstanding equipment and we work hard to back it up with outstanding customer and technical support.

Please let us know what else we can do to assist you. We would be happy to answer your questions.

FOLLETT and FOLLETT HEALTHCARE are registered trademarks of Follett Products, LLC, registered in the US.



801 Church Lane • Easton, PA 18040, USA
Toll free (877) 612-5086 • +1 (610) 252-7301
www.folletticehealthcare.com

01568237R05
© Follett Products, LLC 4/26