

Industry first – Pressurized water sanitizing kits

Compatible with Symphony™ and Symphony Plus™ ice and water dispensers

01089572 – for use with Follett® water filtration systems
(uses existing pre-filter bowl to introduce sanitizer)

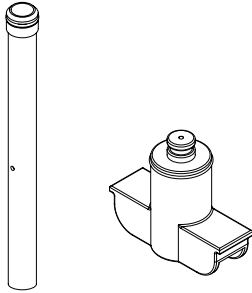

The pressurized water sanitizing process facilitates a complete sanitization of the entire ice and water dispenser when performed in conjunction with the standard ice machine and dispenser cleaning/sanitizing process.

01089580 – for use without Follett water filtration system

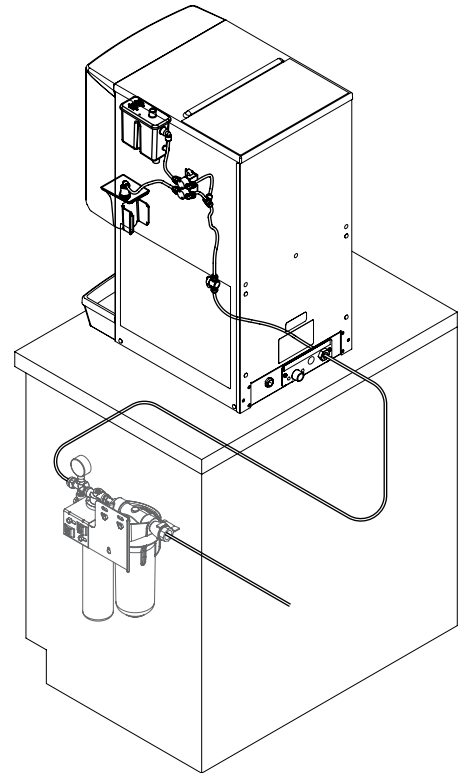
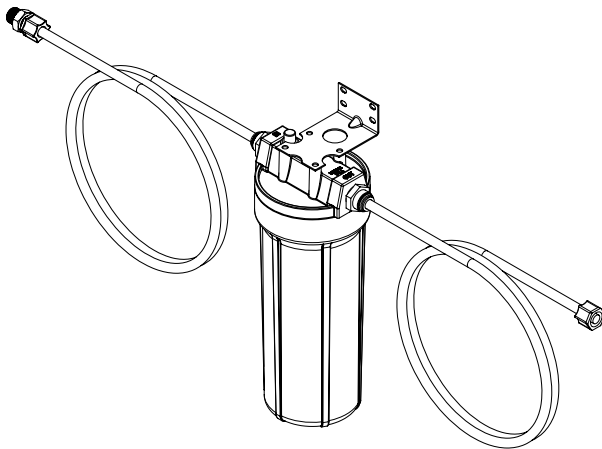

Kits sanitize internal pressurized water lines shown above.

Item number	Description	Contents	Net price
01089572	For use in Follett dispensers with a Follett water filtration system models 00130229, 00978957, 01050442 ¹	(1) Dip tube (1) Bypass plug	\$40
01089580	For use in Follett dispensers without a Follett water filtration system ¹	(1) Filter housing (1) Dip tube (12') Tubing	\$90
00979674	Nu-Calgon IMS-III Sanitizer	(1) 16 oz bottle	\$20

¹ Requires sanitizing solution: Use Nu-Calgon IMS-III sanitizing concentrate or equivalent 200 ppm active quaternary solution.

Order online at www.follettice.com (US only) or
call +1 800.523.9361 (US and Canada only) or +1 610.252.7301

SYMPHONY and SYMPHONY PLUS are trademarks of Follett Products, LLC.
FOLLETT and FOLLETT HEALTHCARE are registered trademarks of Follett Products, LLC, registered in the US.
Follett reserves the right to change specifications at any time without obligation. Certifications may vary depending on country of origin.



801 Church Lane | Easton, PA 18040, USA
+1 610.252.7301 | 800.523.9361 | folletthealthcare.com

6830-20210828 | © Follett Products, LLC